

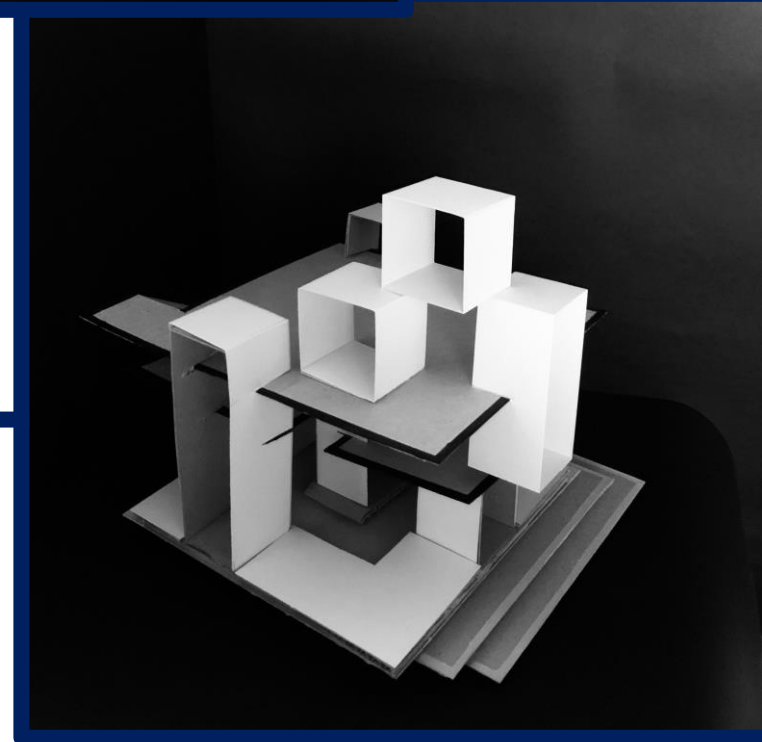

TARA DURN
OSNOVE ARHITEKTONSKOG PROJEKTIRANJA

MENTORI:
IZV.PROF.ART. STANKO STERGARŠEK, D.I.A.,
ASISTENT ANETA MUDRONJA PLETENAC, D.I.A

STUDIJ KRAJOBRAZNA ARHITEKTURA
1. SEMESTAR BS-AK.GOD. 2020/21.

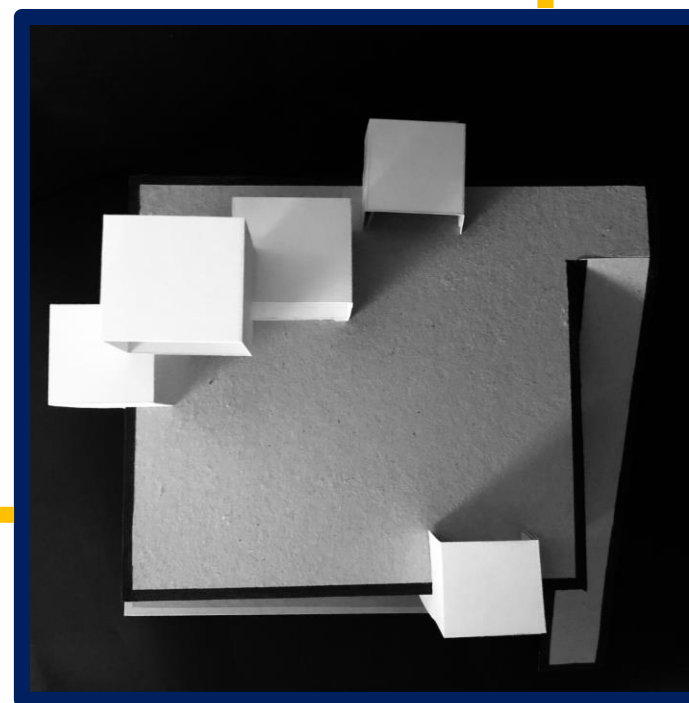

KONAČNA MAKETA U BOJI

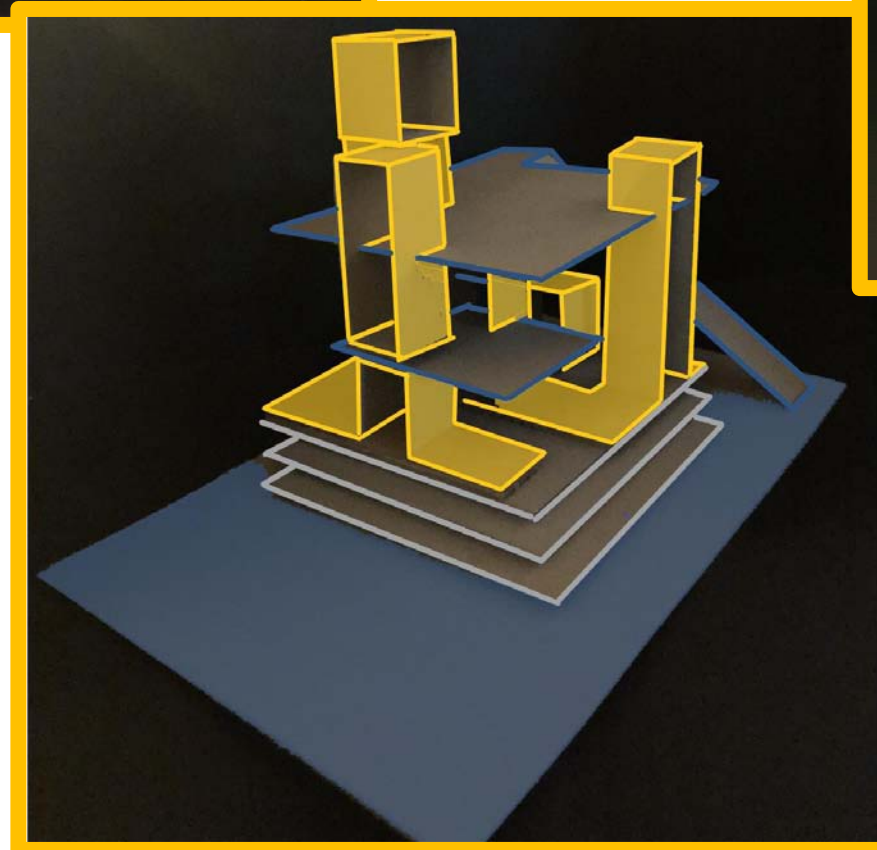
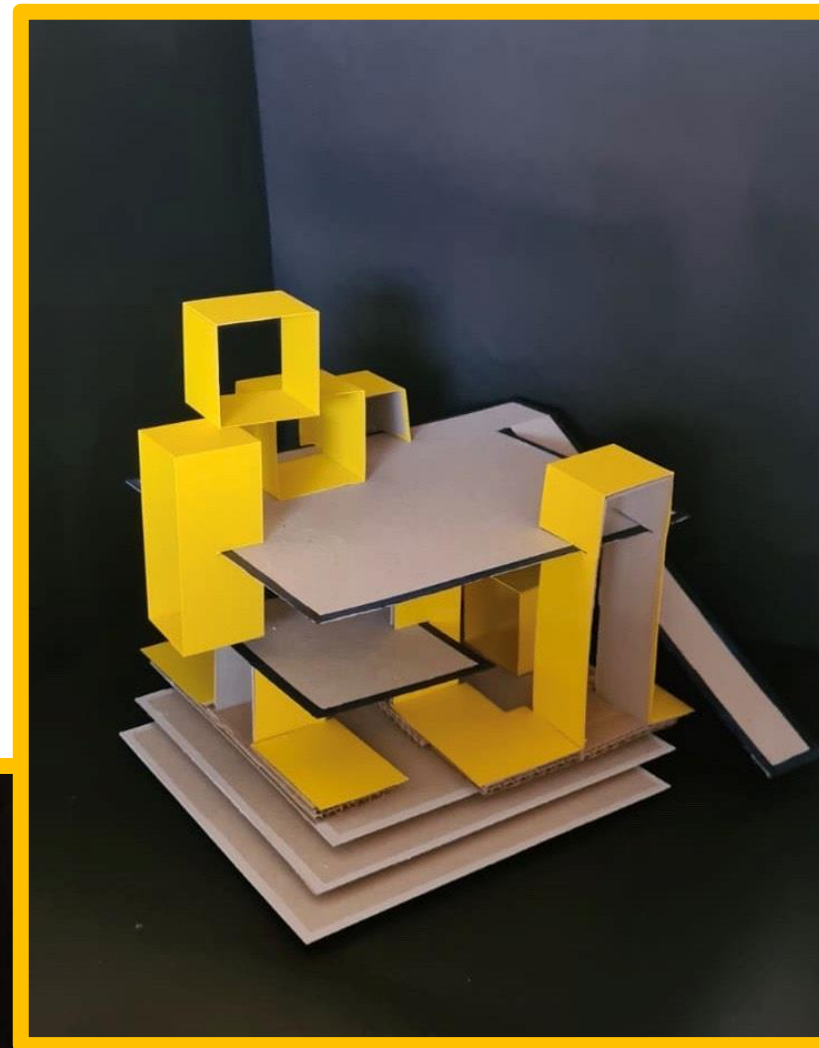
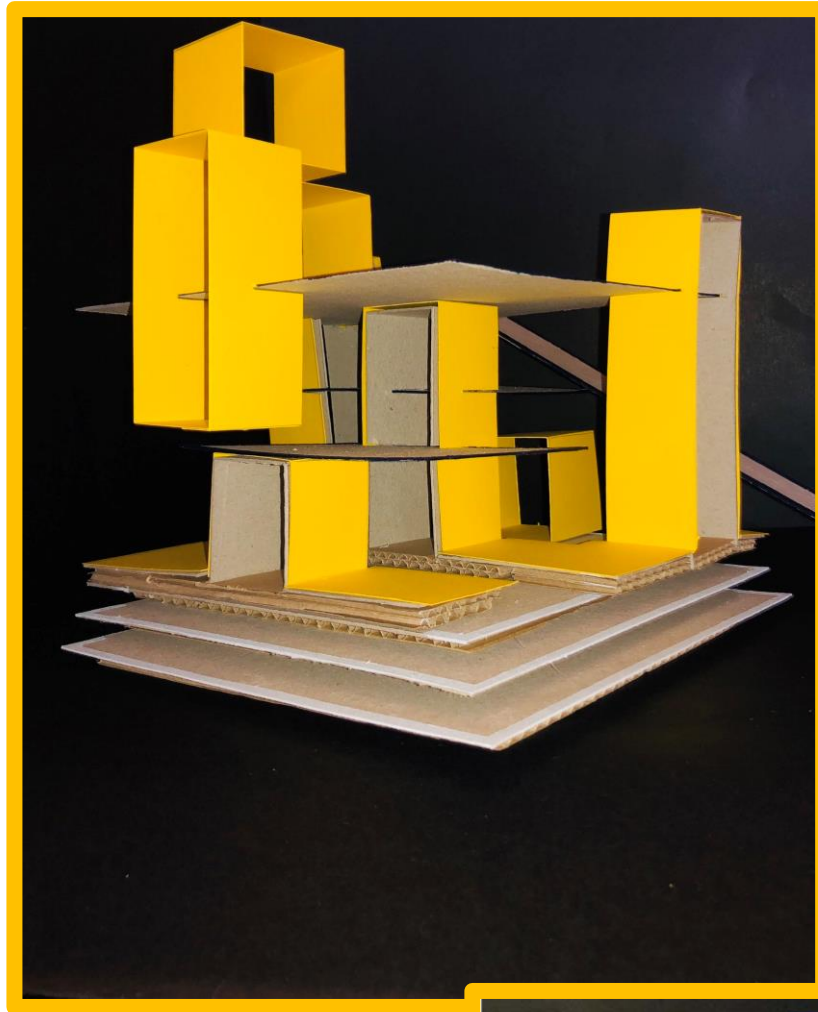

KONAČNA MAKETA BEZ BOJA

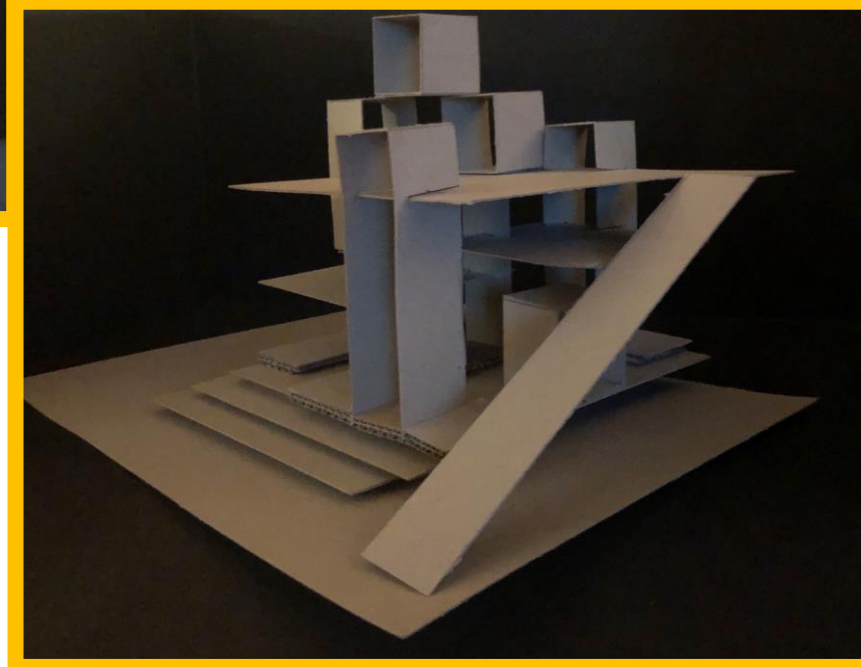
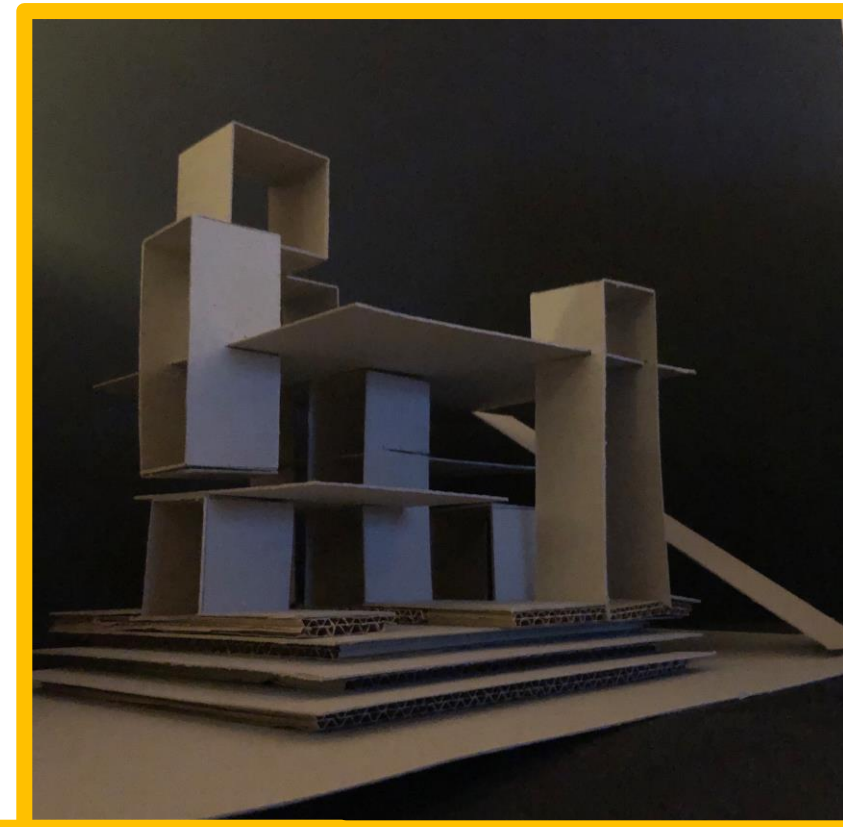
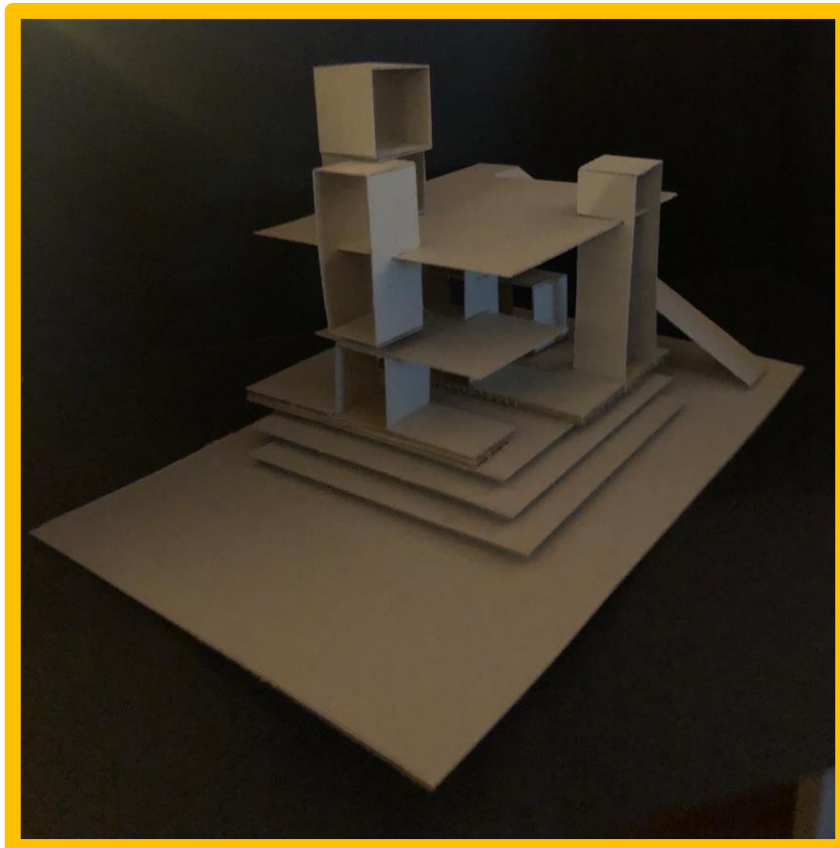

PERSPEKTIVA

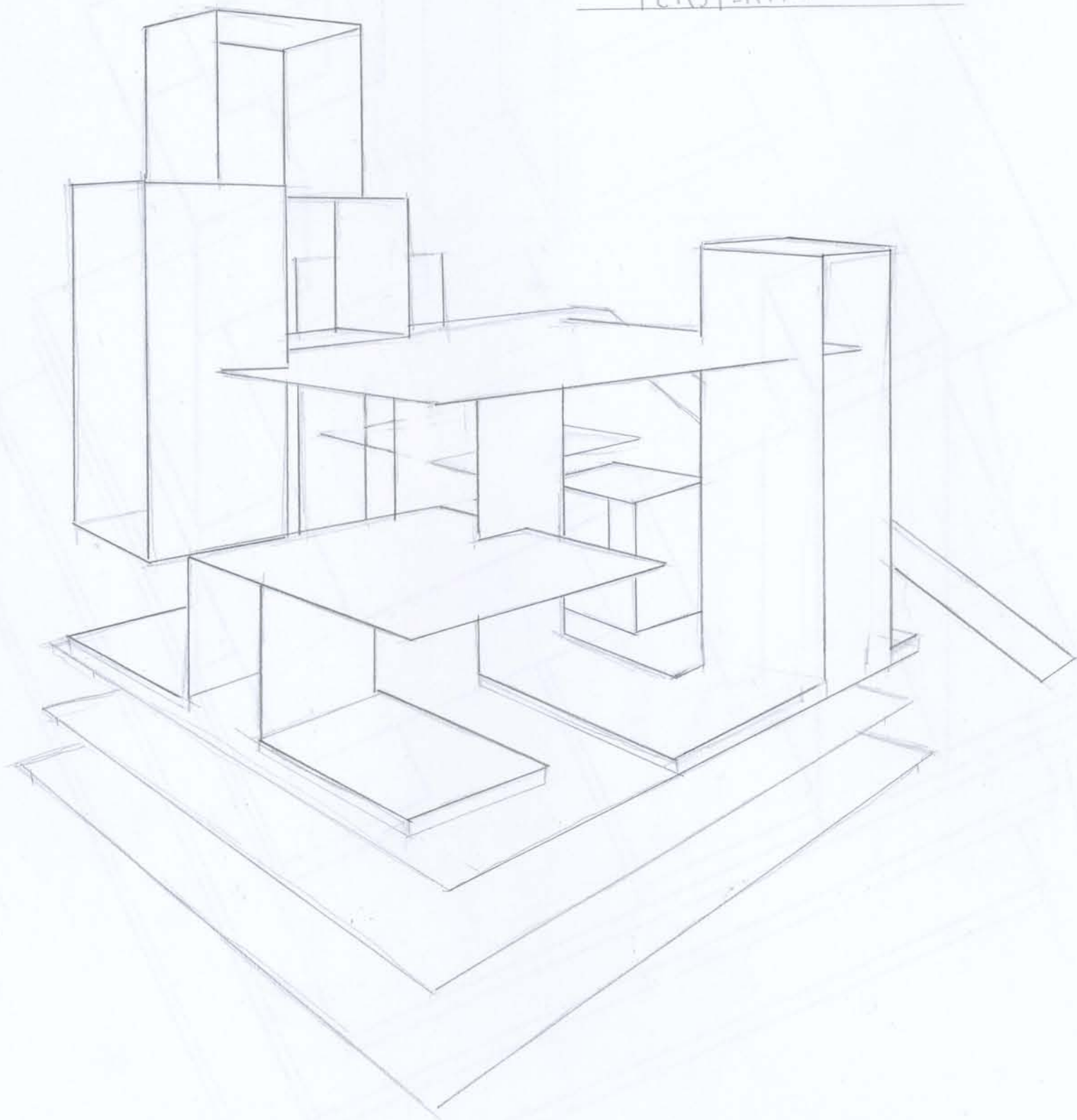

TARA DORN

AKSONOMETRIJA

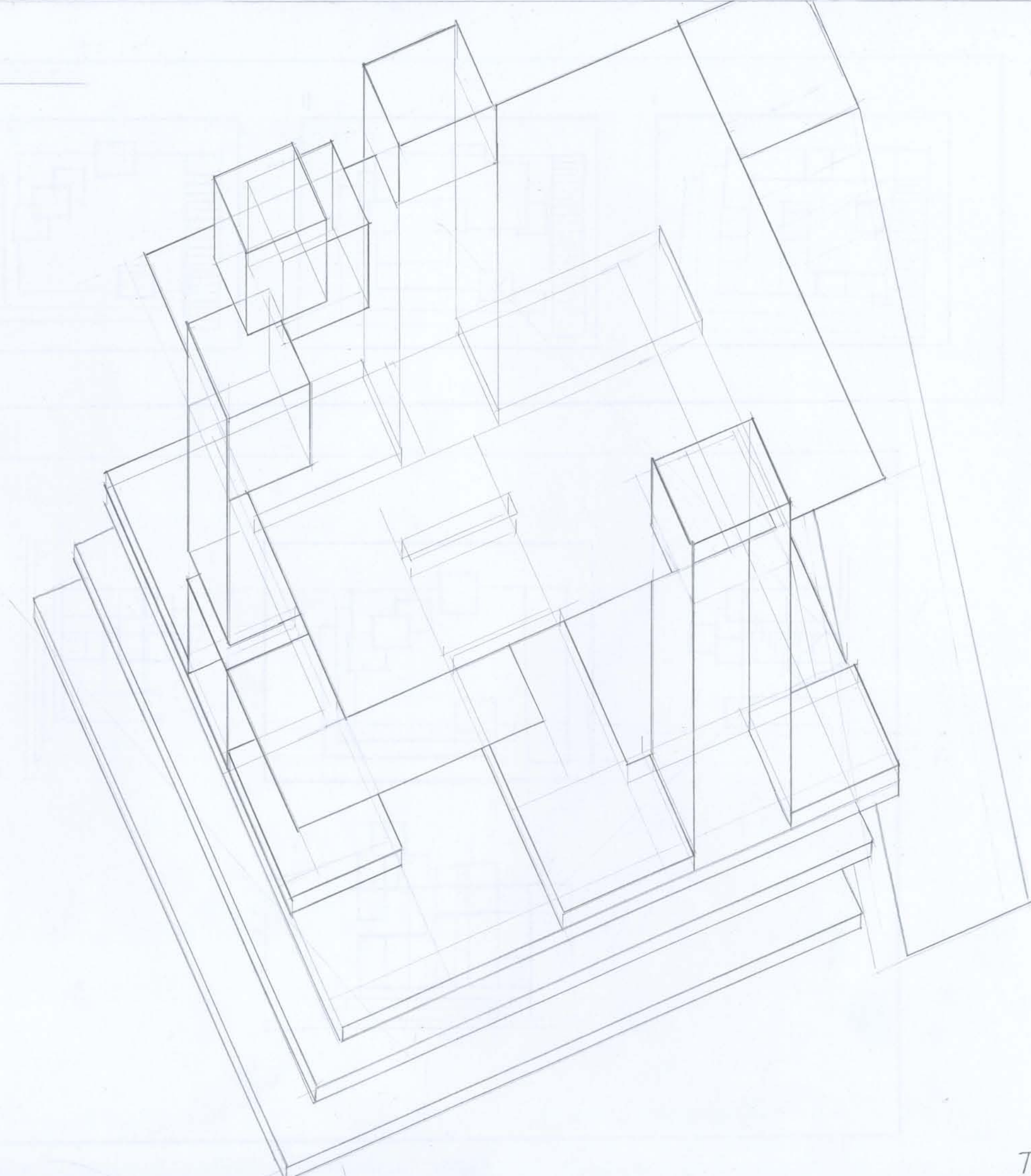

TARA DURN

TLOCRTI

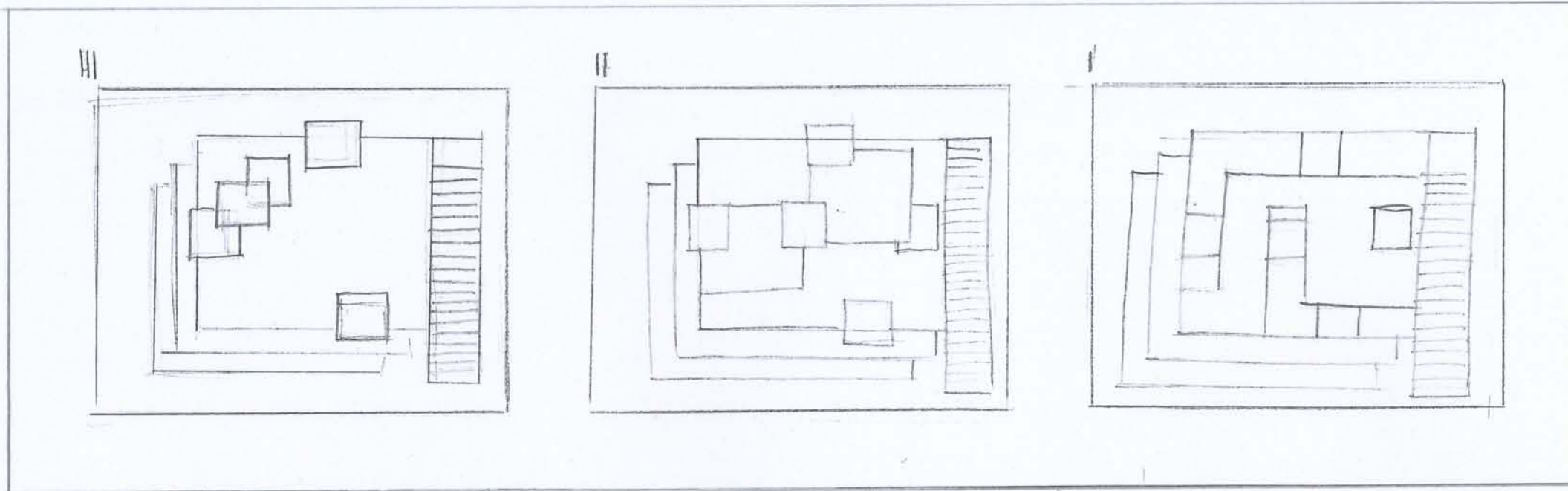

POGLEDI

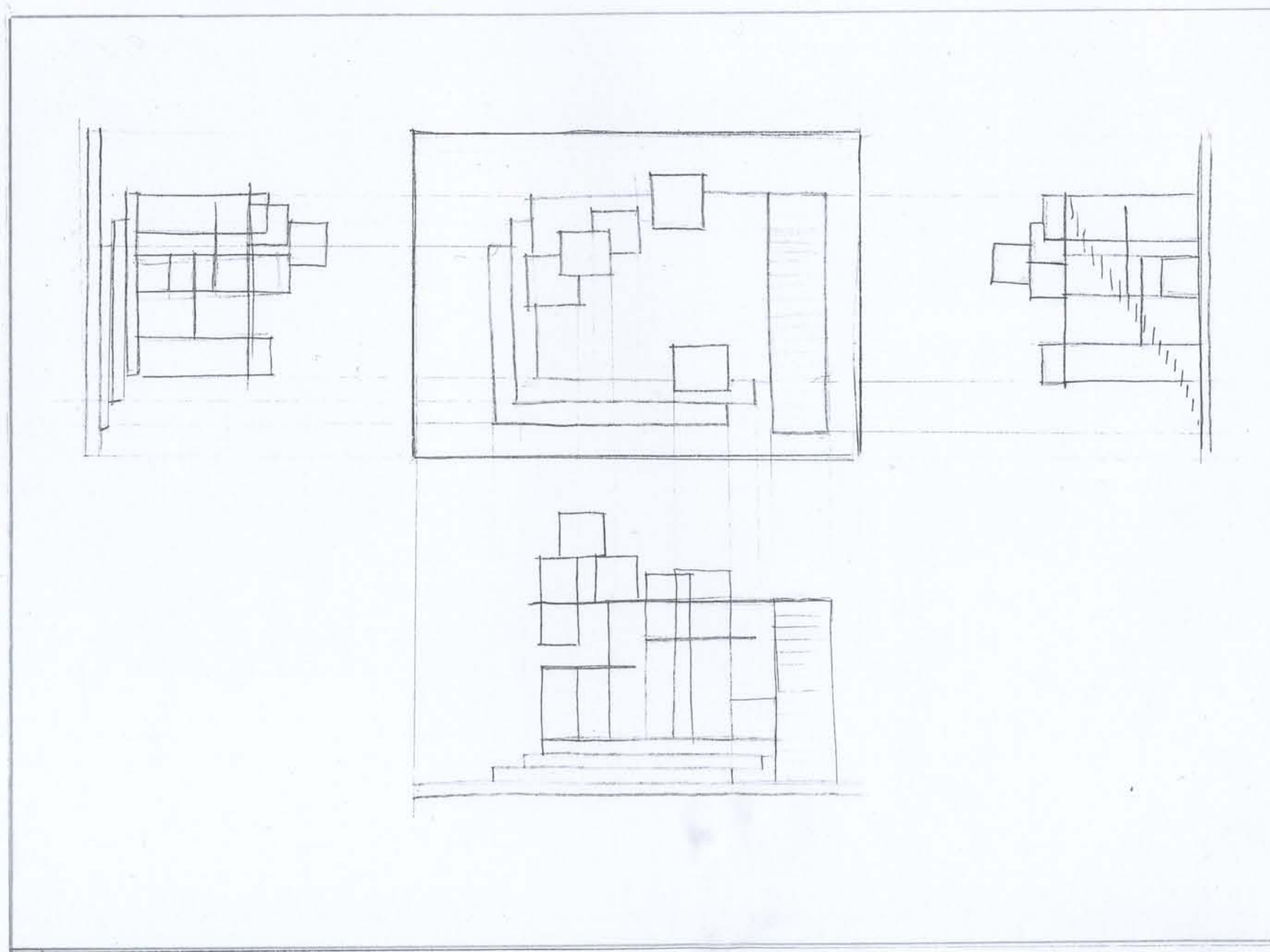

TARA DURN

SLIKE RADNE MAKETE

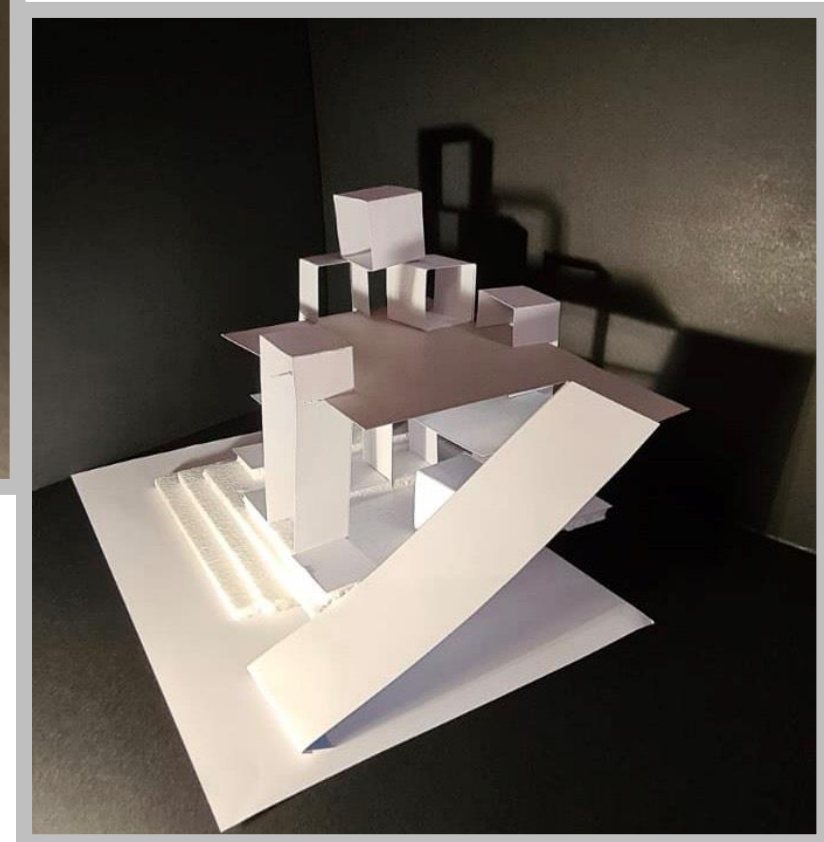
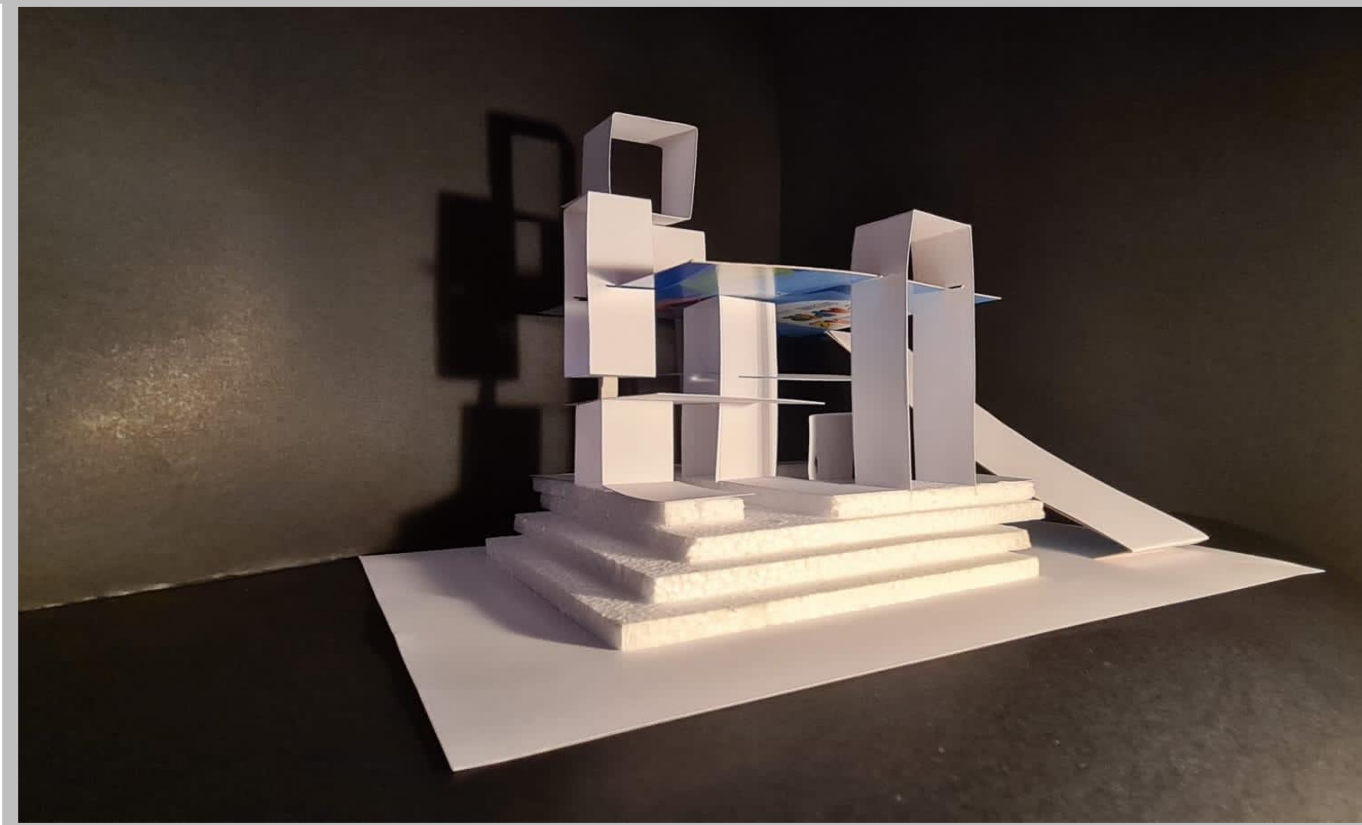
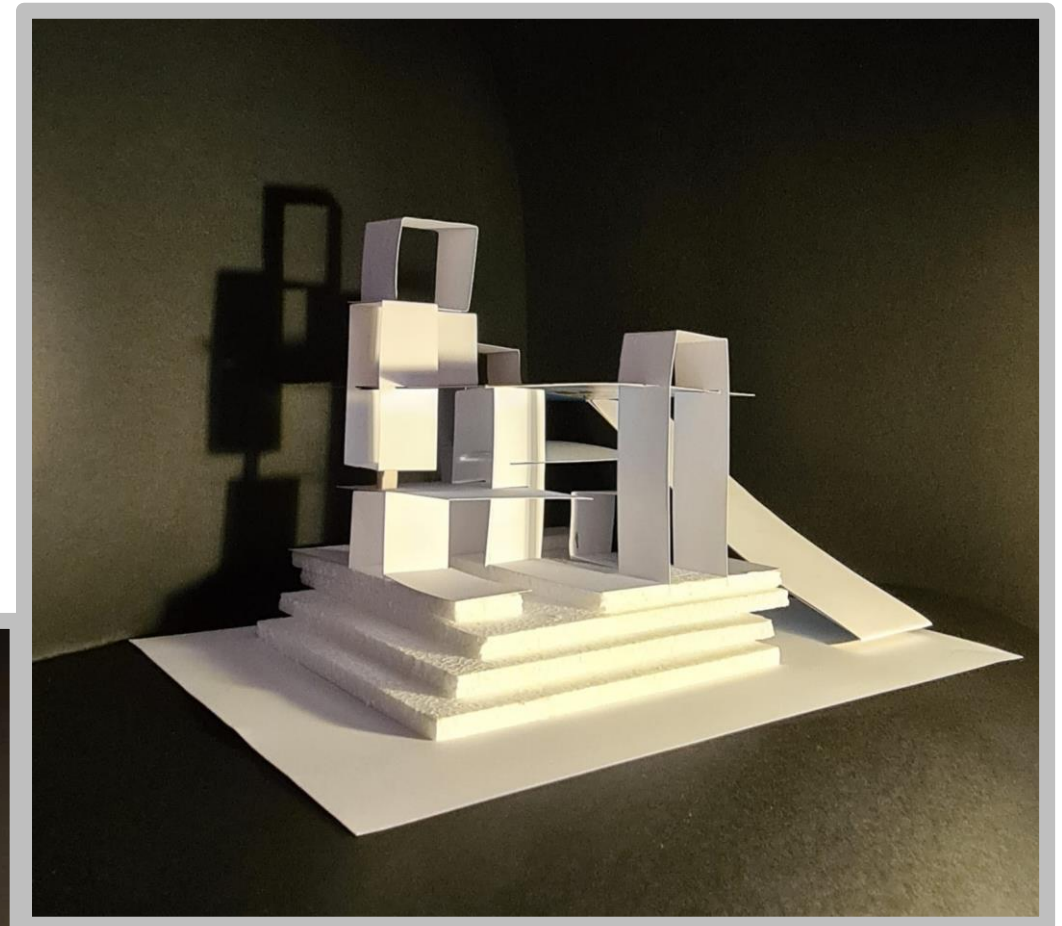
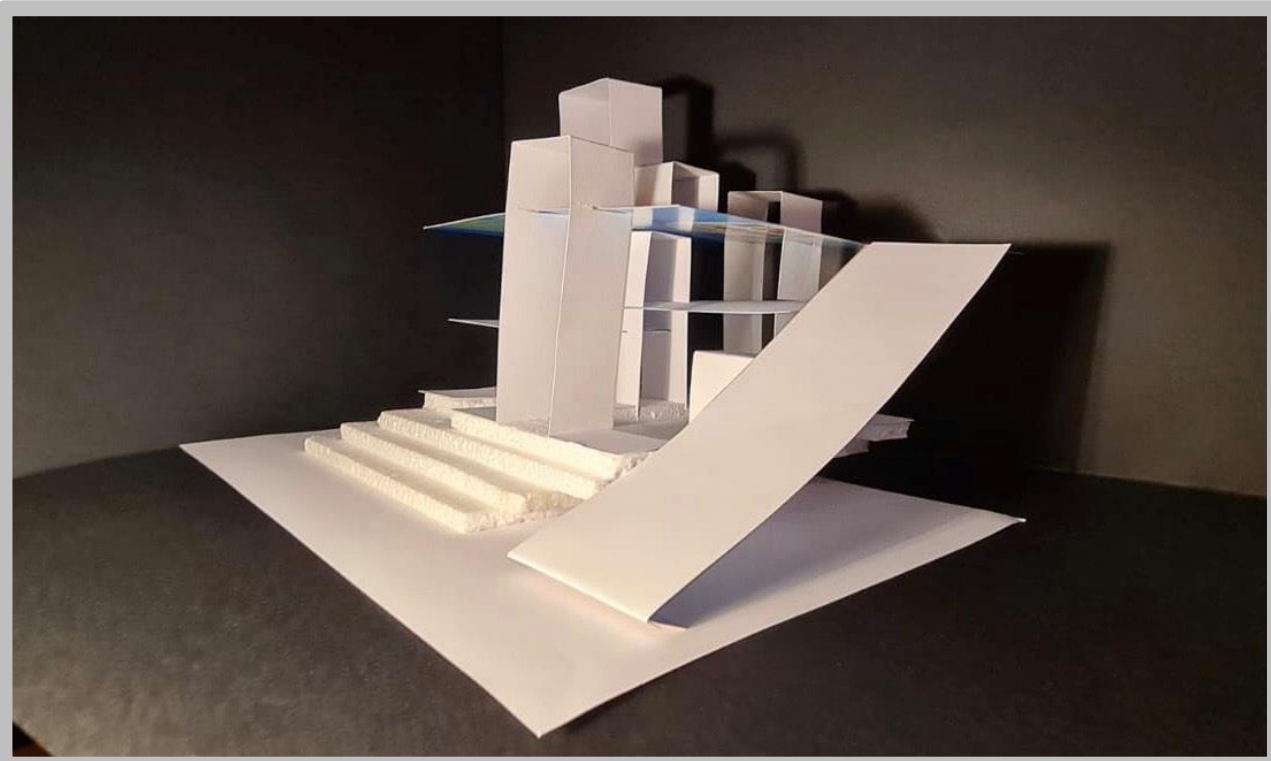

RADNA MAKETA

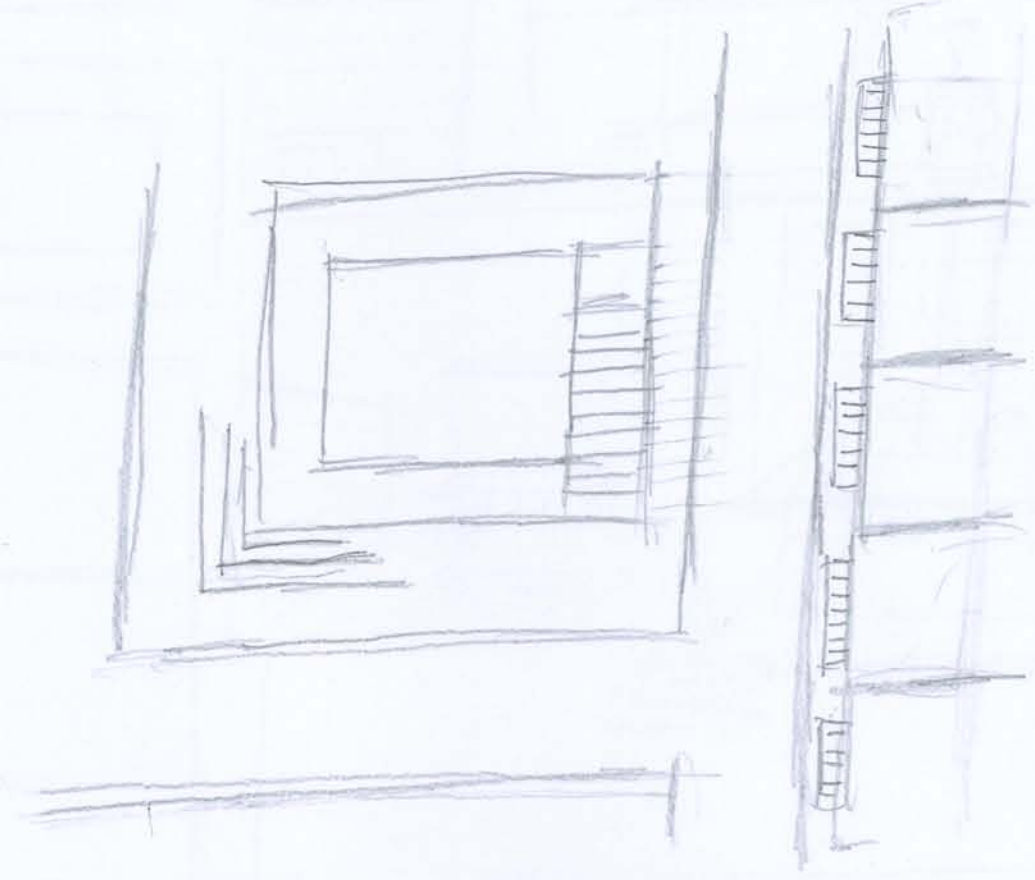
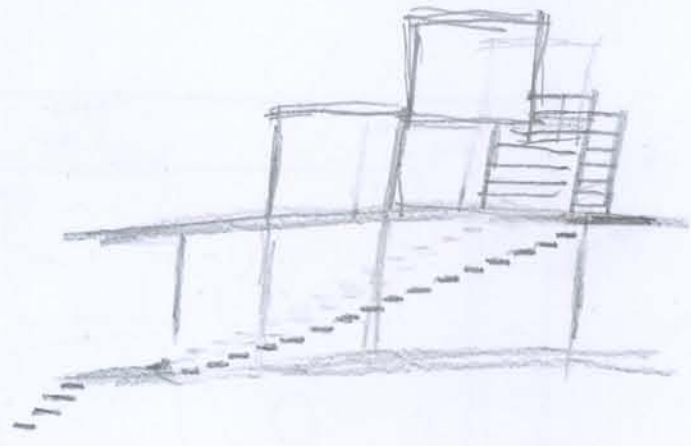
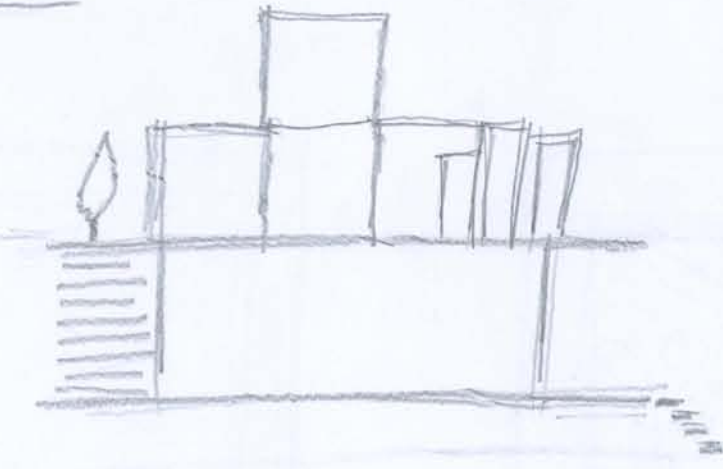
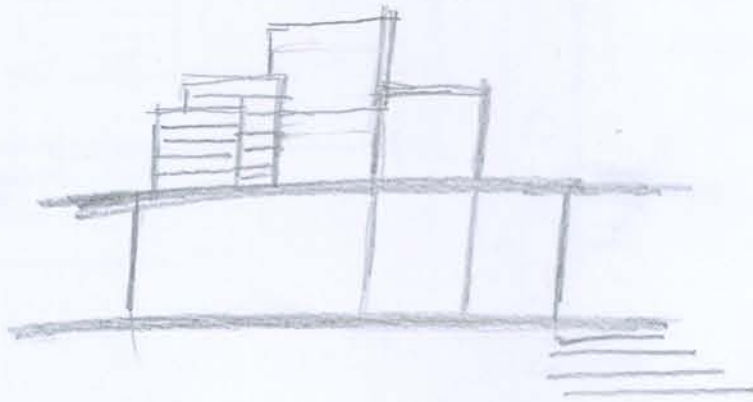
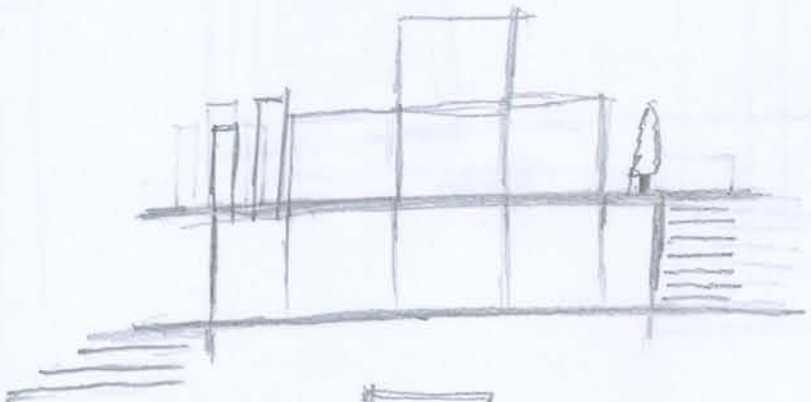
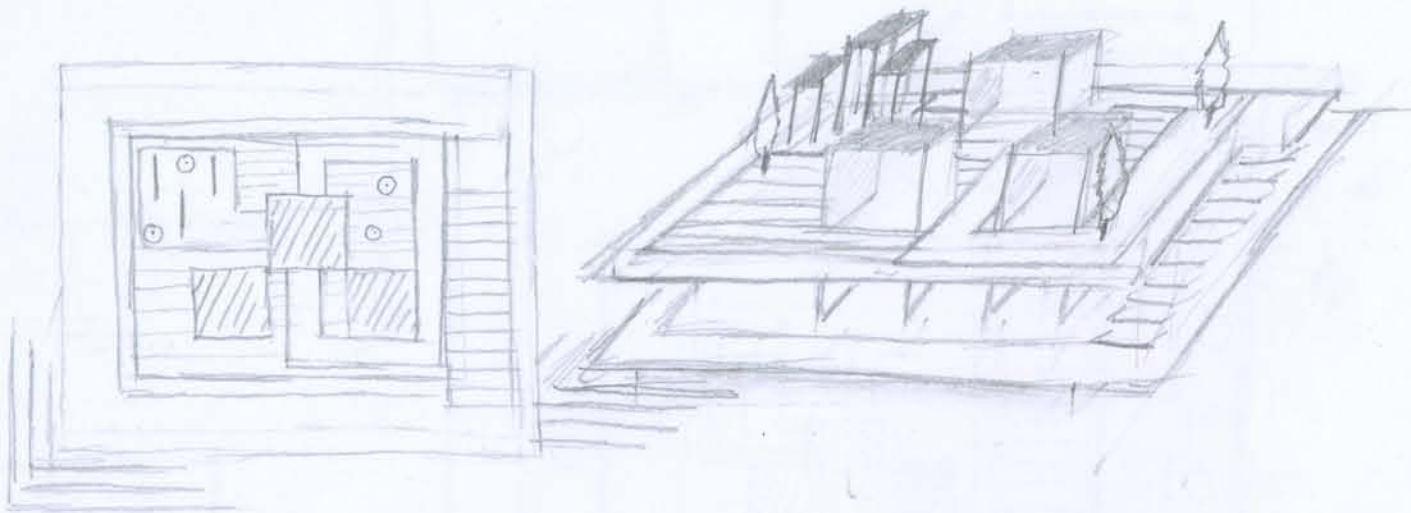

TARA DURN

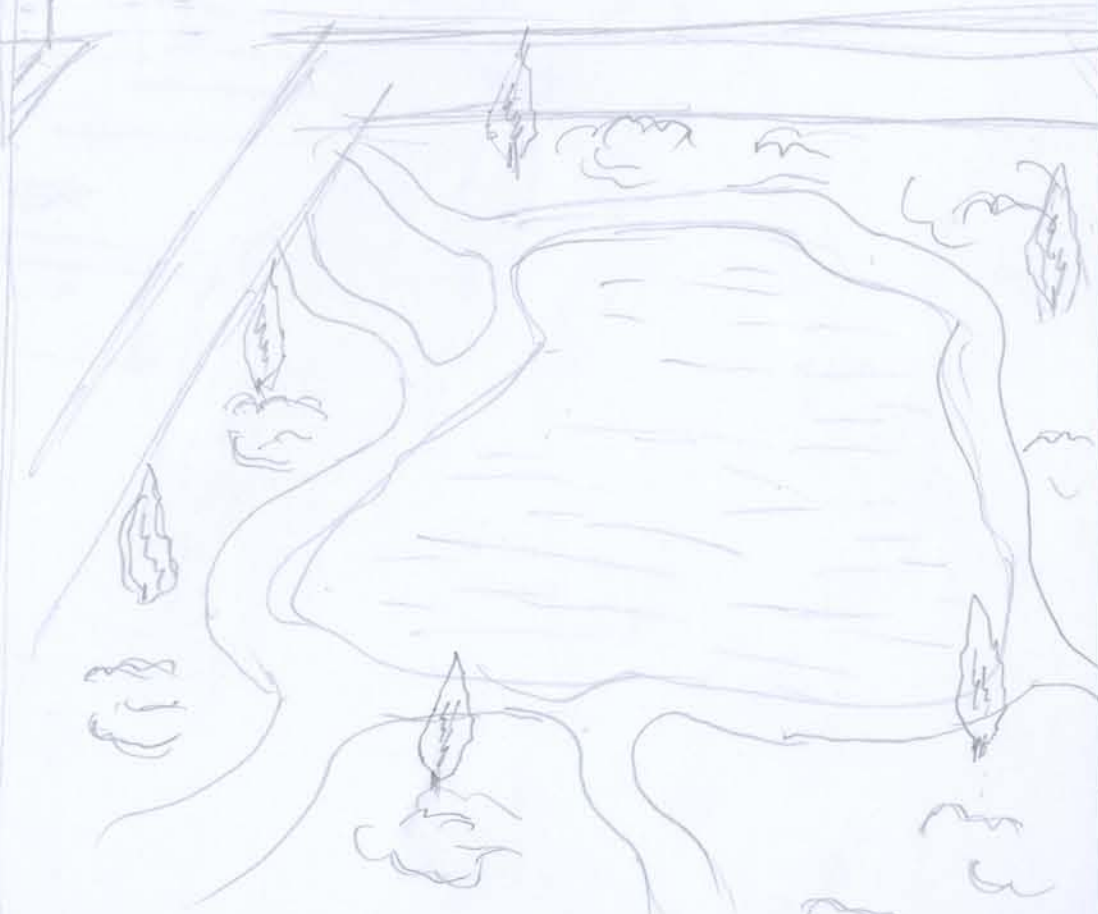
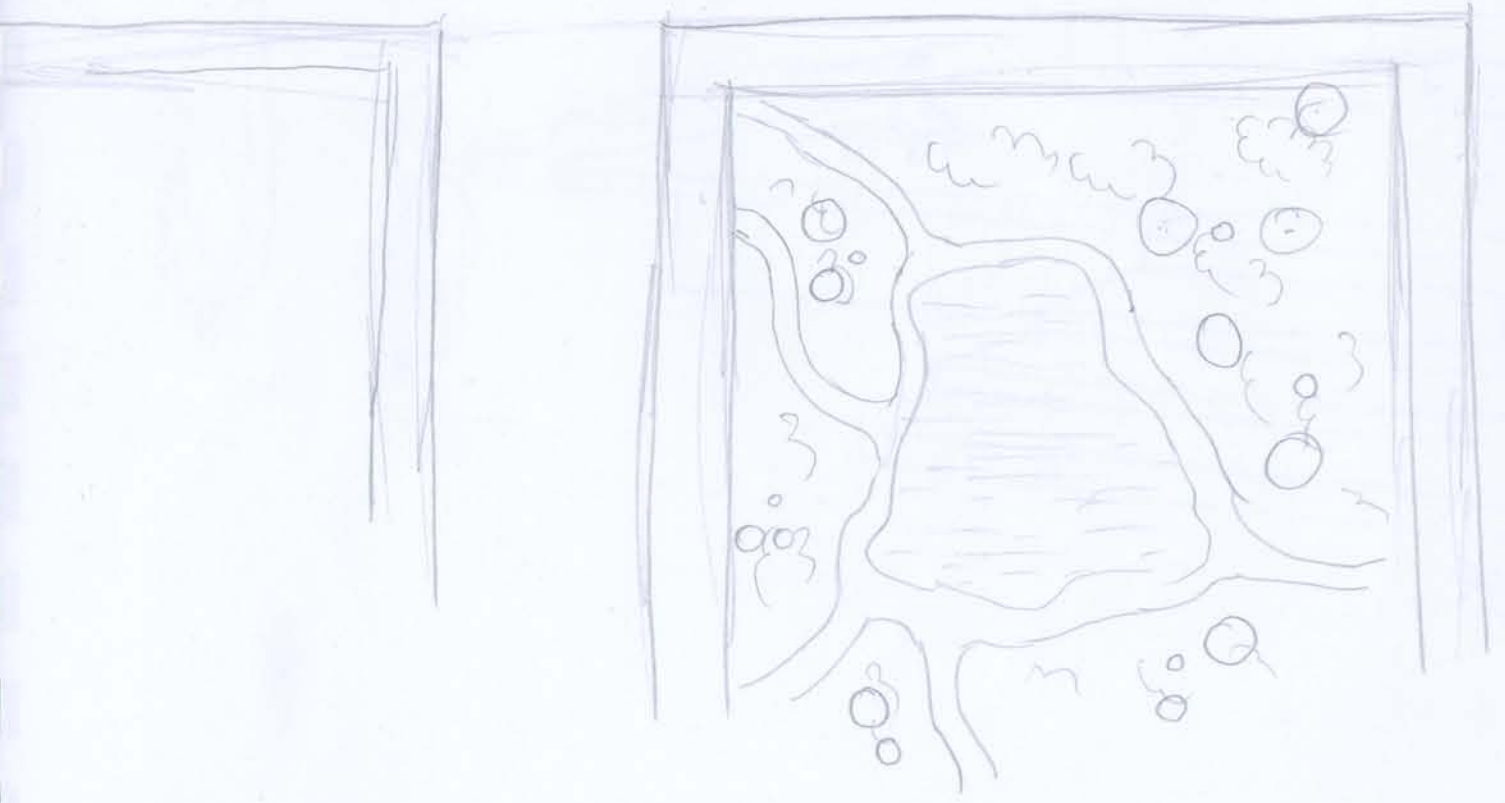
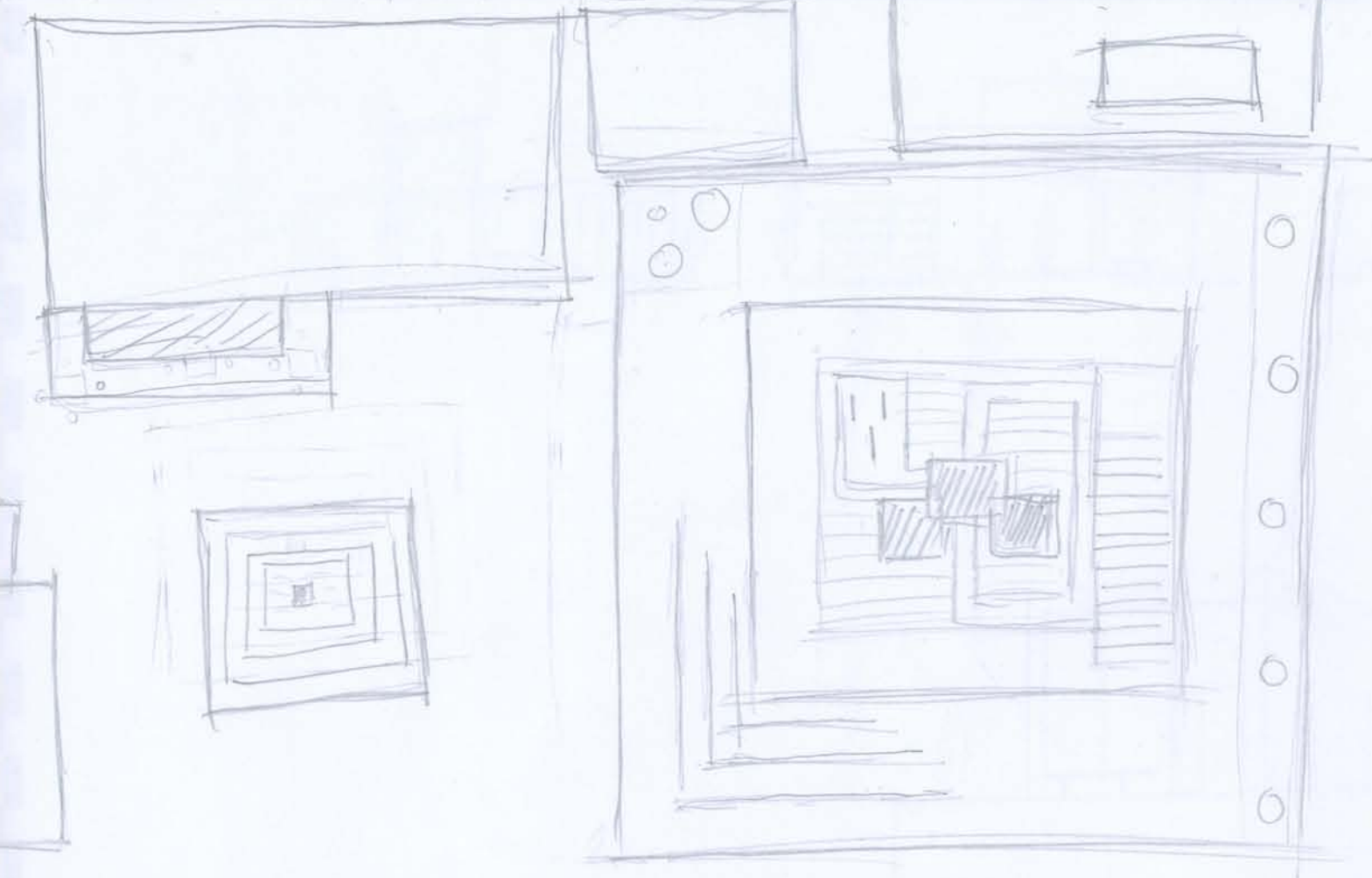

TARA DURN

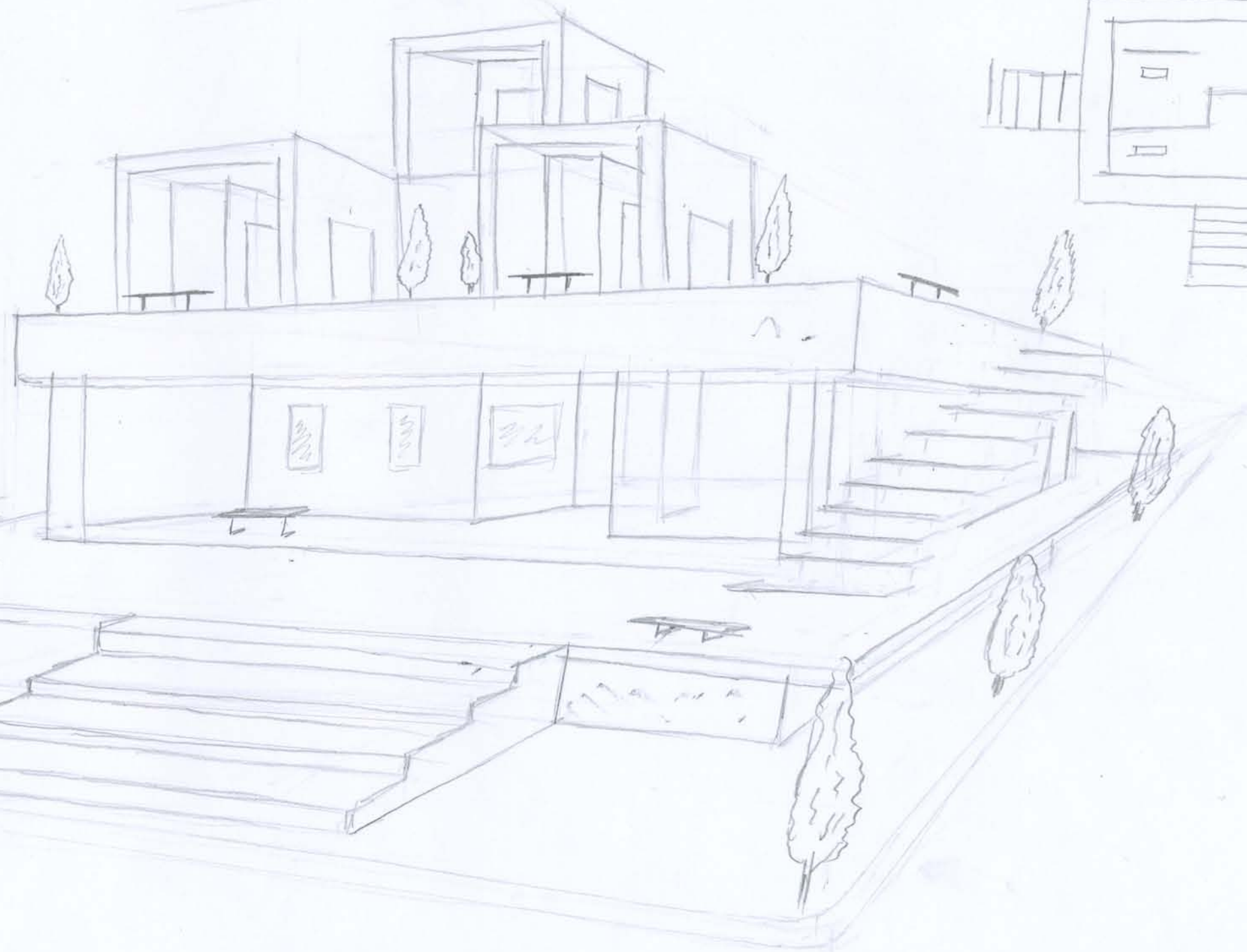
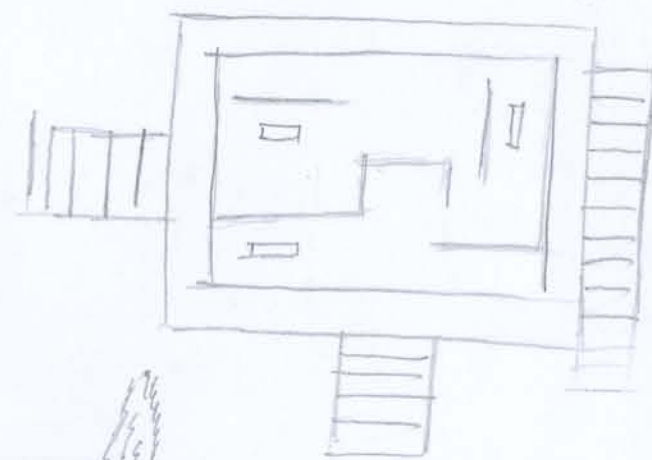
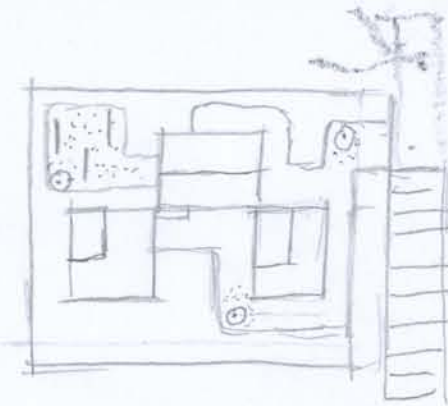
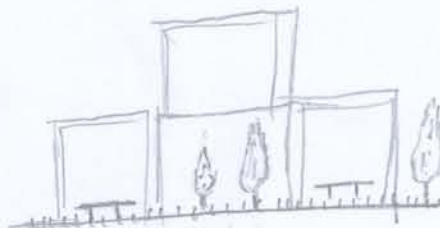
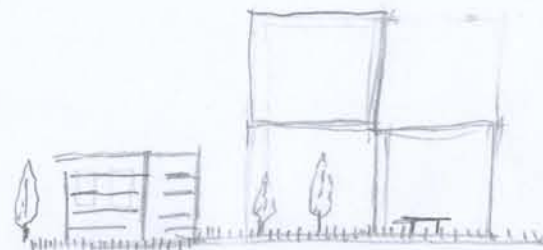
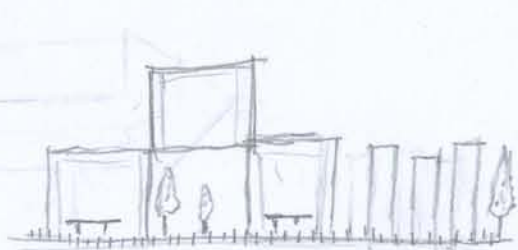

TARA DURN

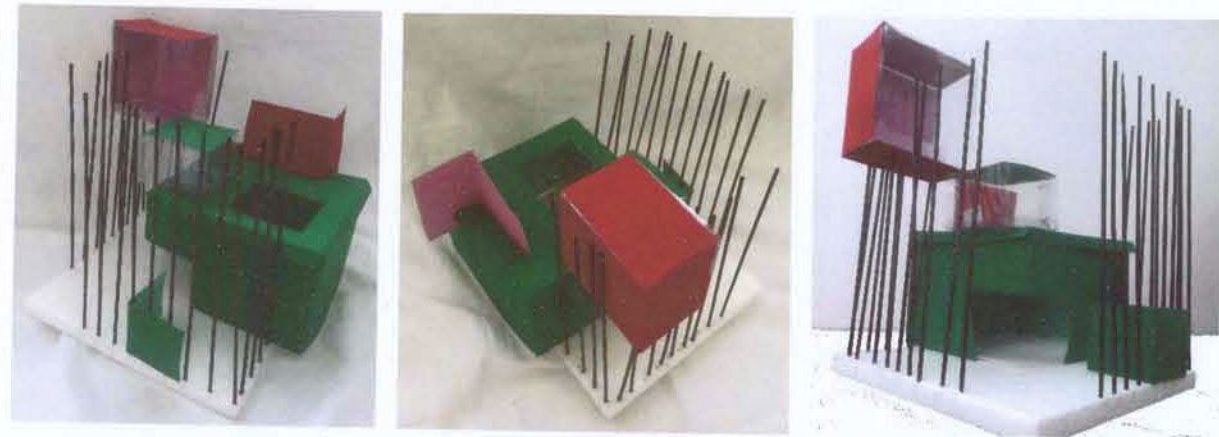

EMA SRDELIĆ

OSNOVE ARHITEKTONSKOG PROJEKTIRANJA

MENTORI: izv.prof.art. Stanko Stergaršek, d.i.a., asistent Aneta Mudronja Pletenac, d.i.a.

STUDIJ KRAJOBRAZNA ARHITEKTURA - 1. semestar Bs - ak. god. 2020./2021.

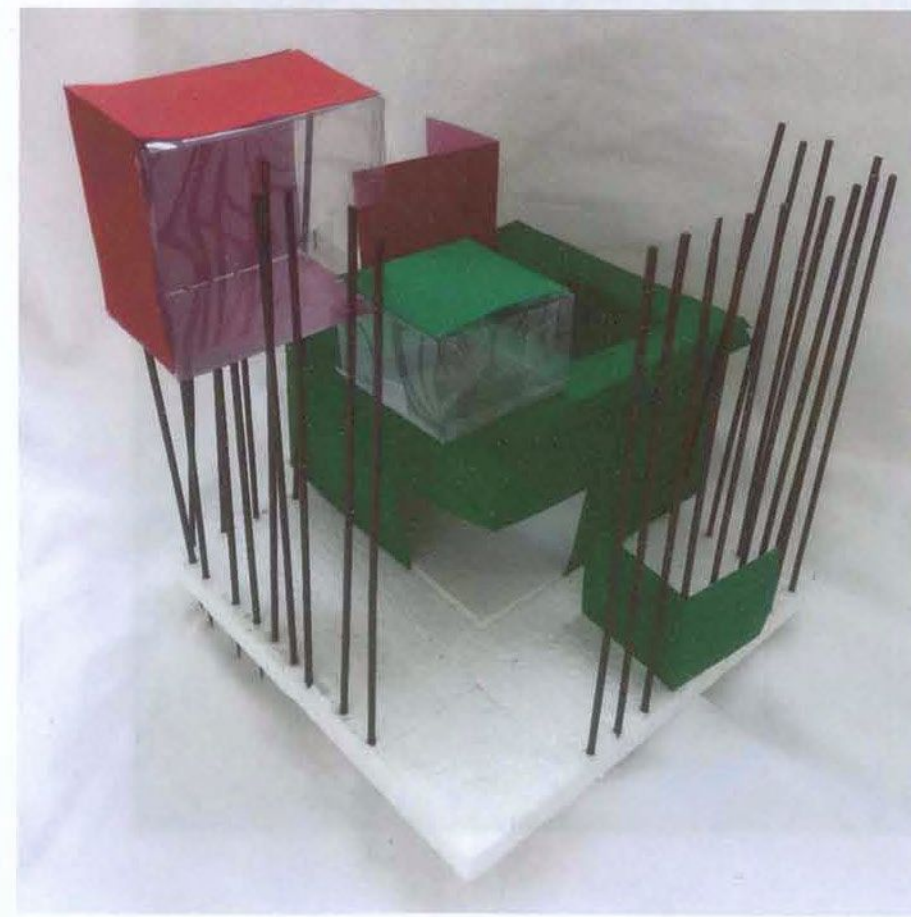
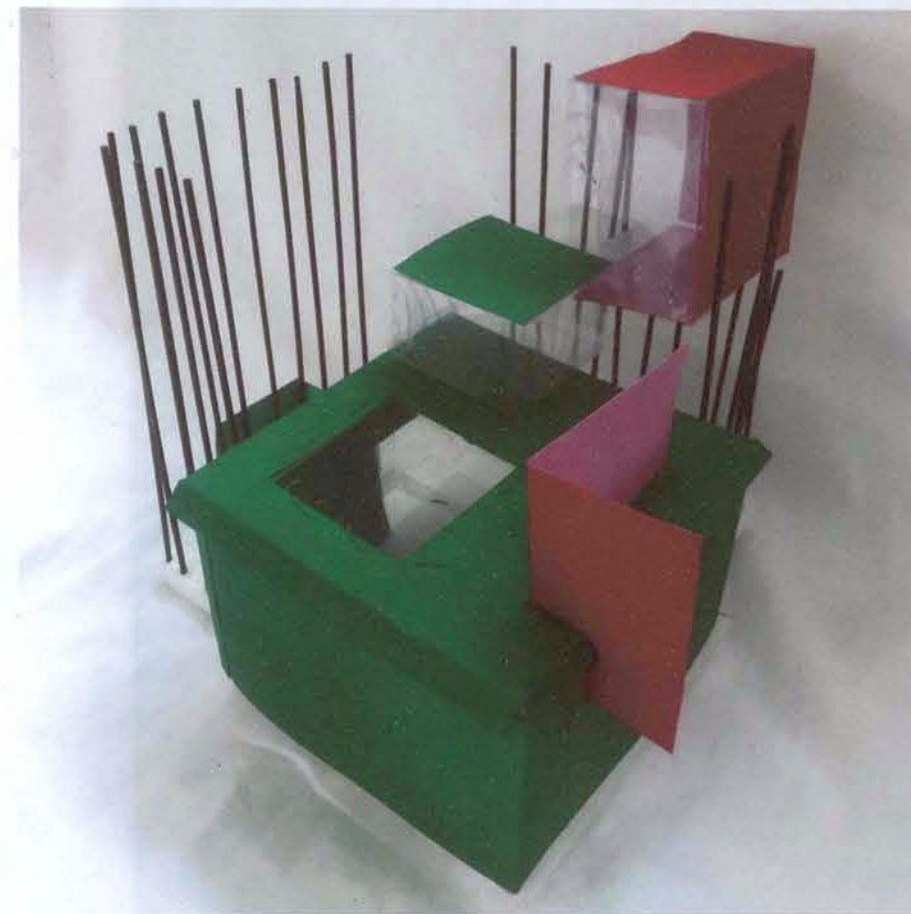
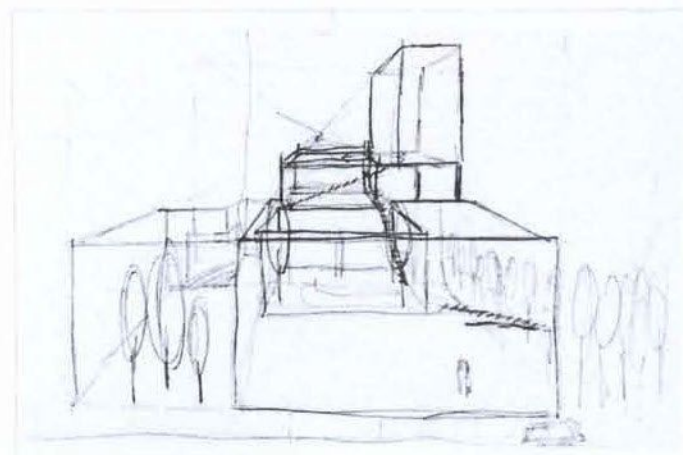

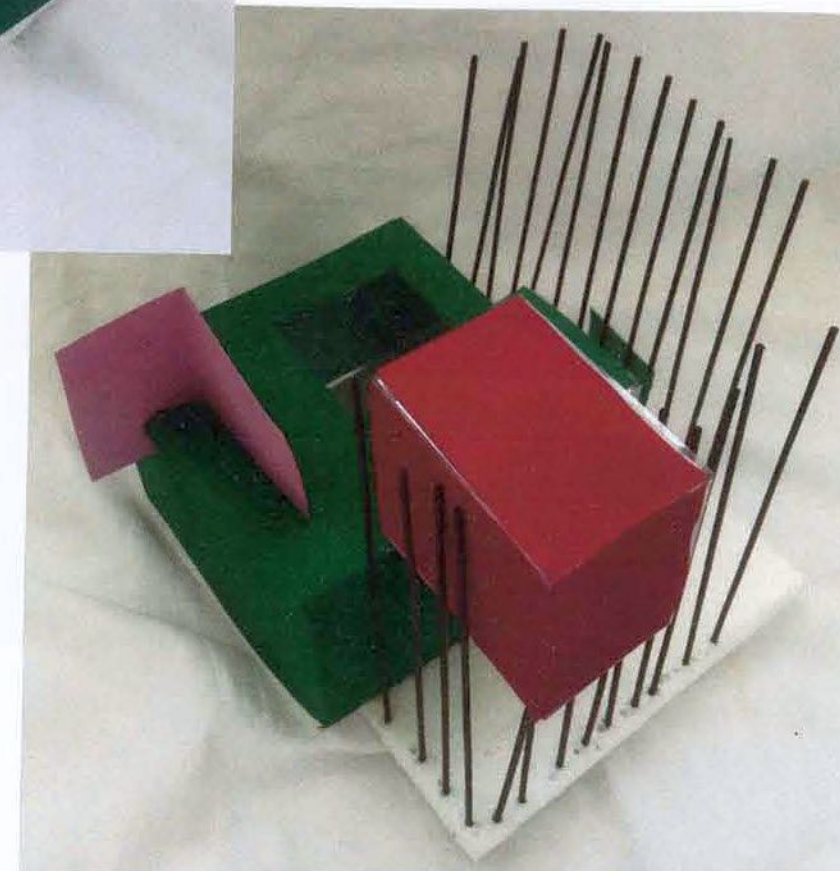
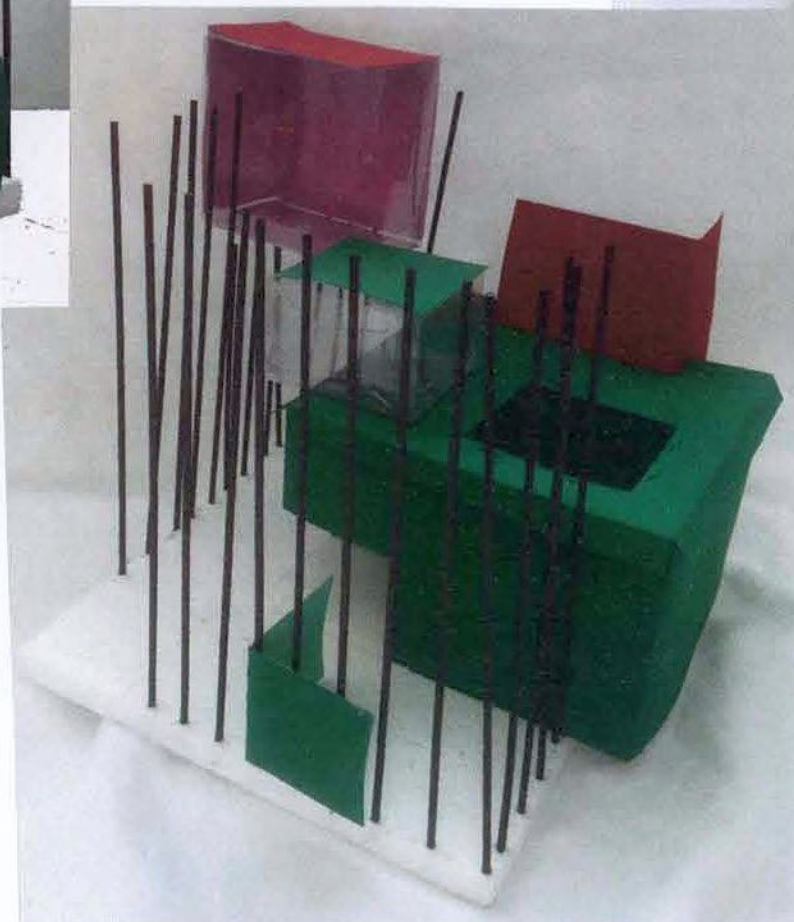
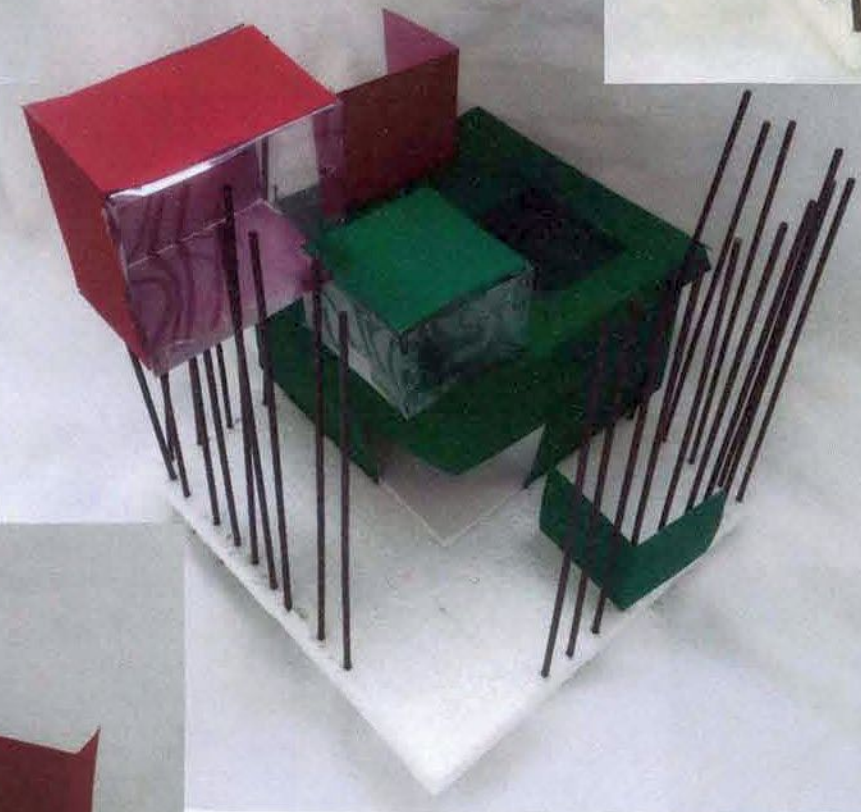
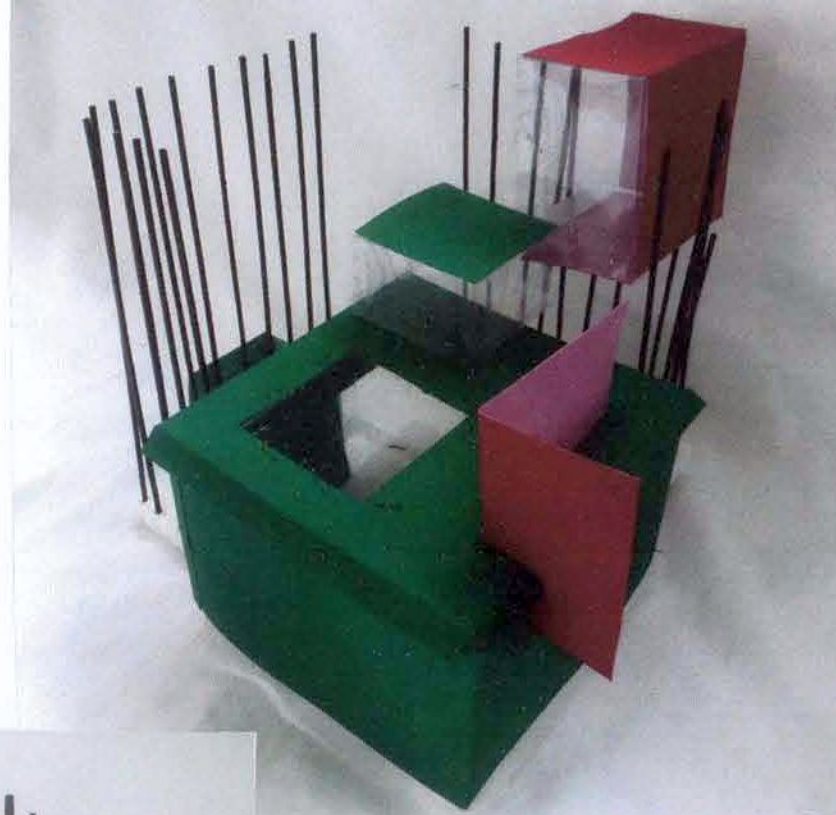

EMA SRDELIC

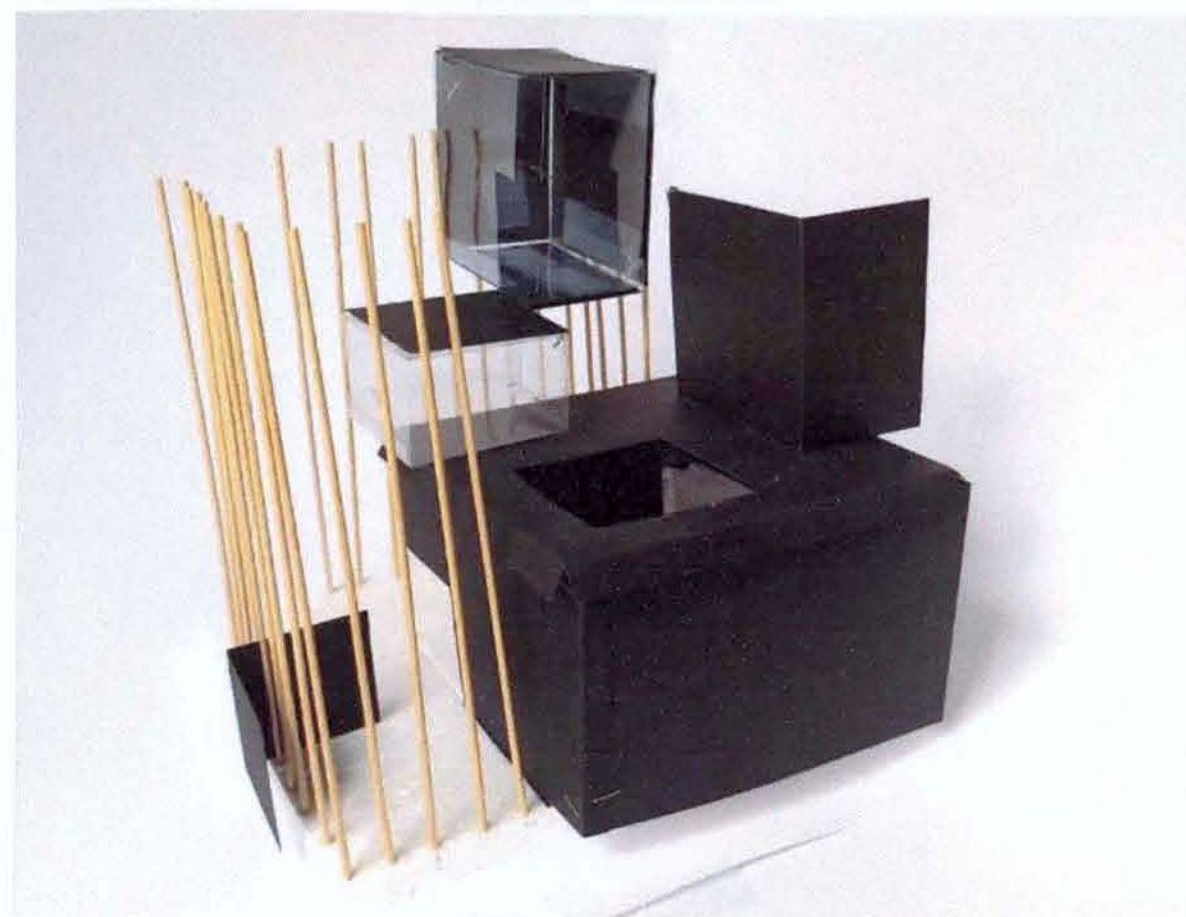

PRIJEDLOZI BOJA

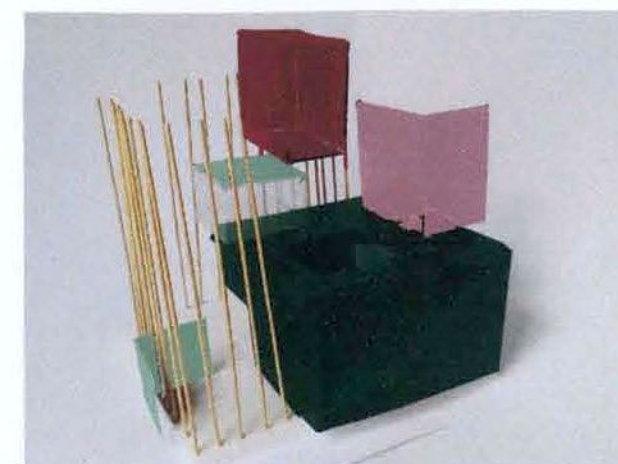
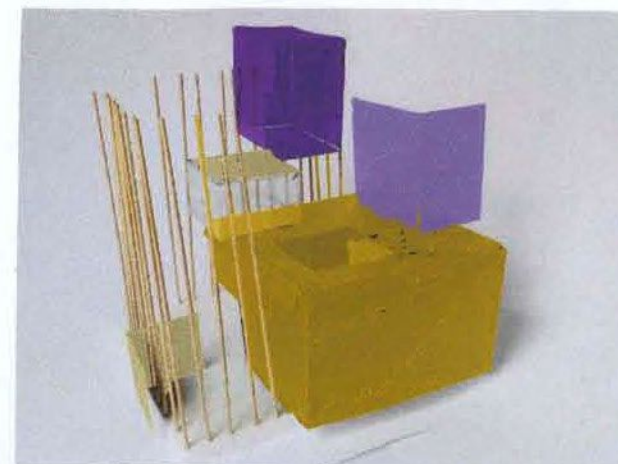
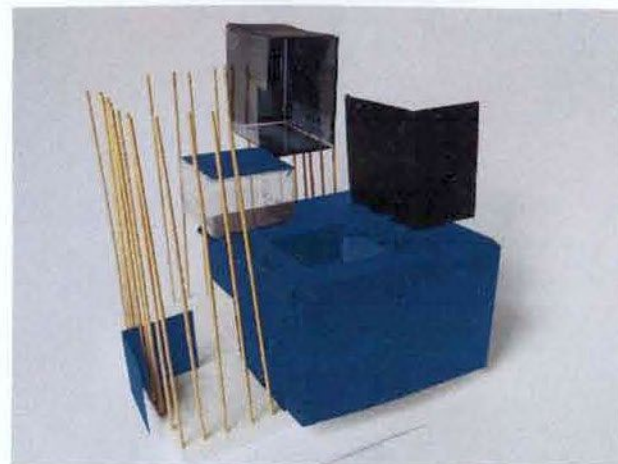
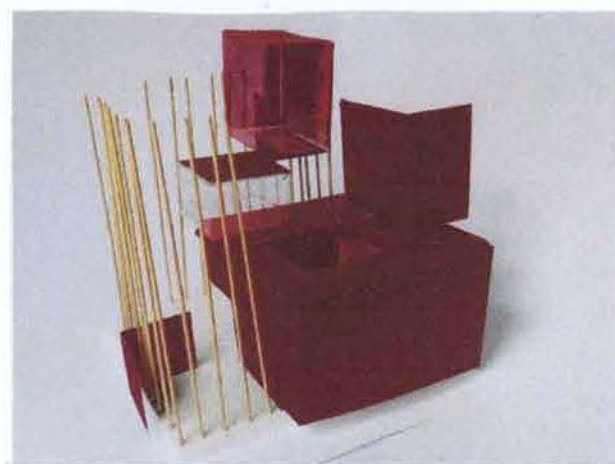

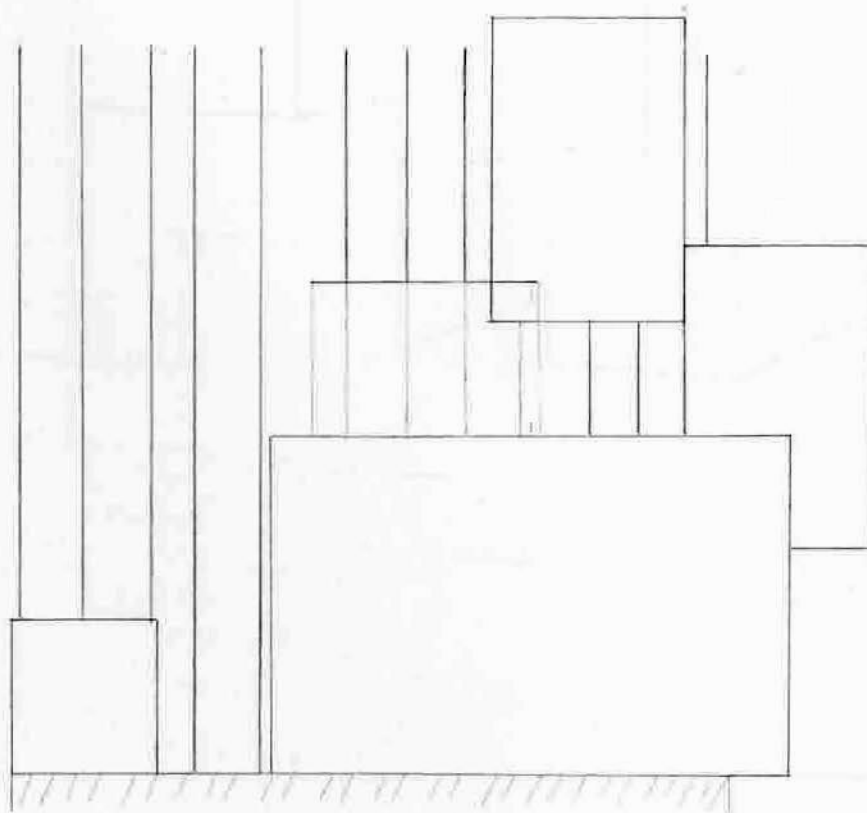
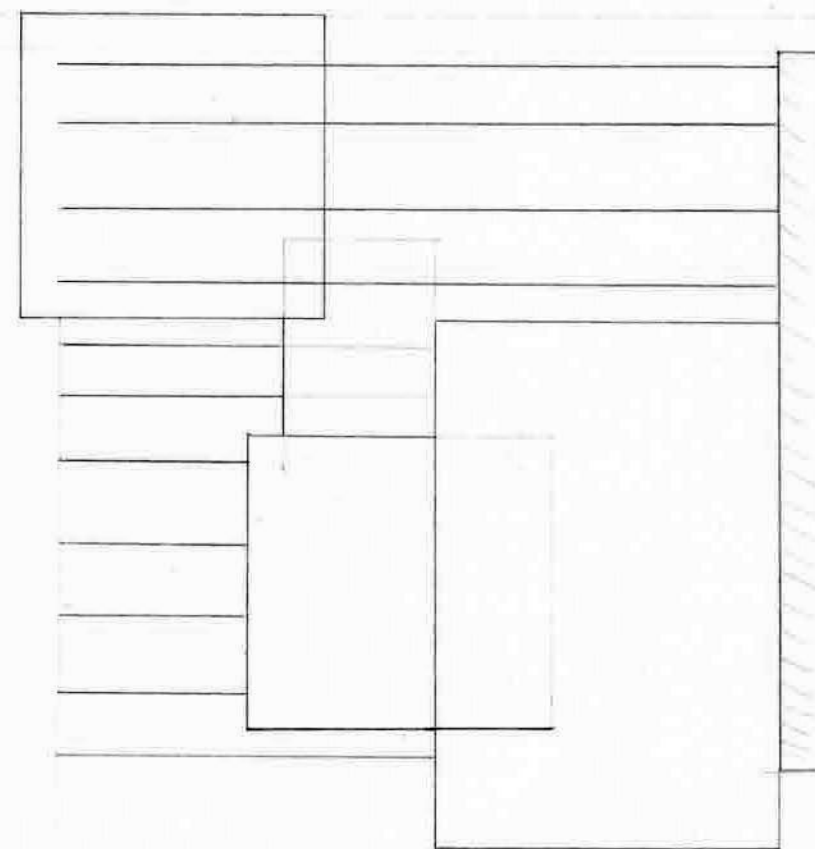
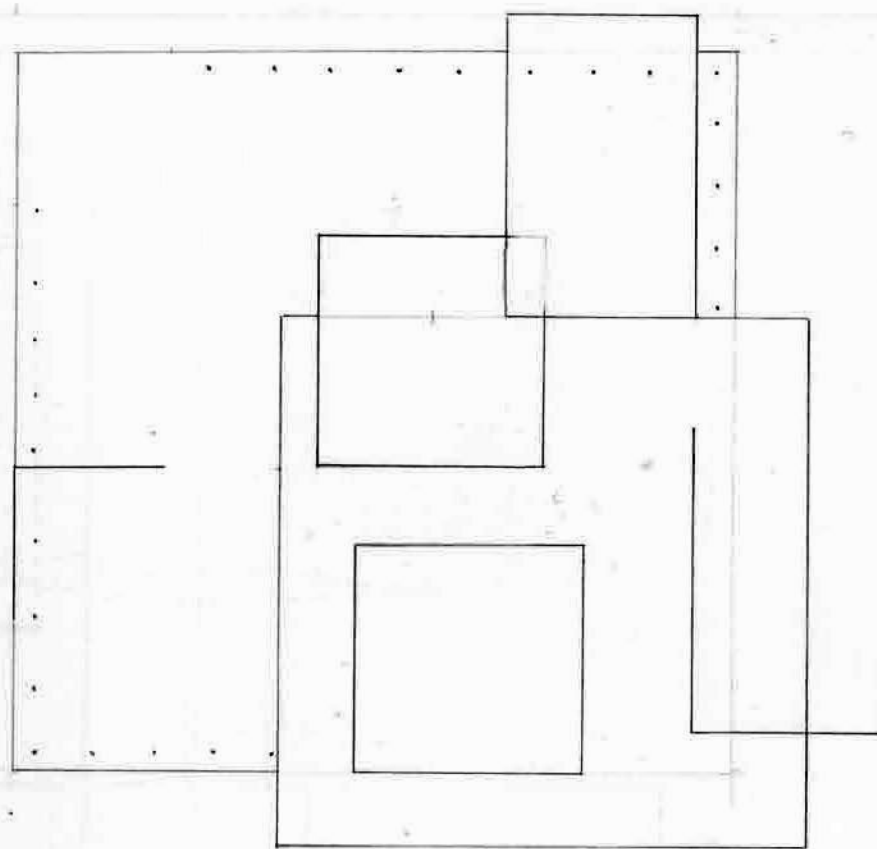
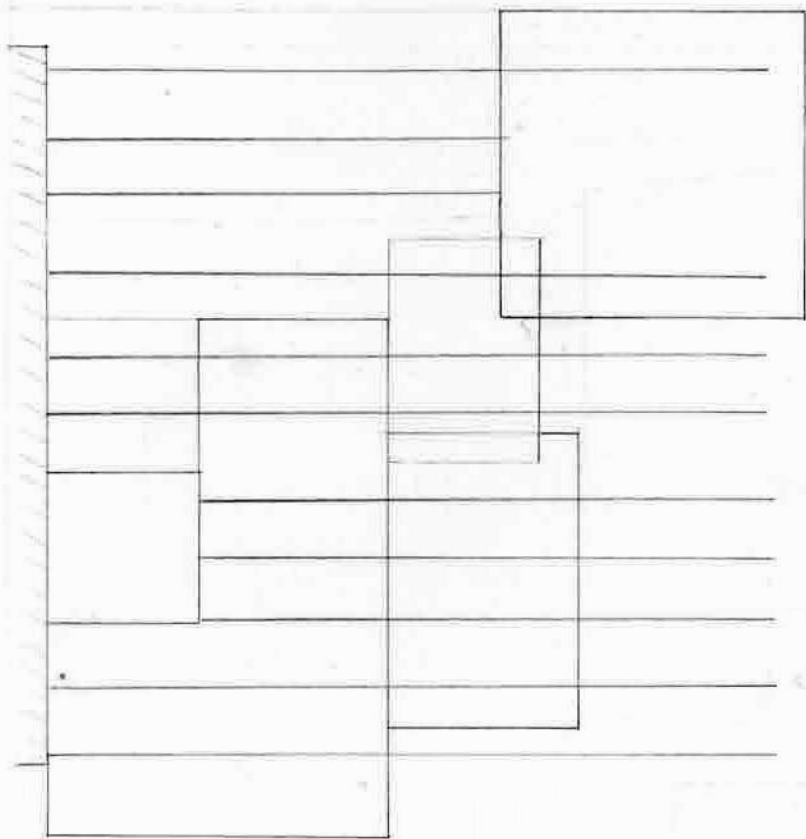

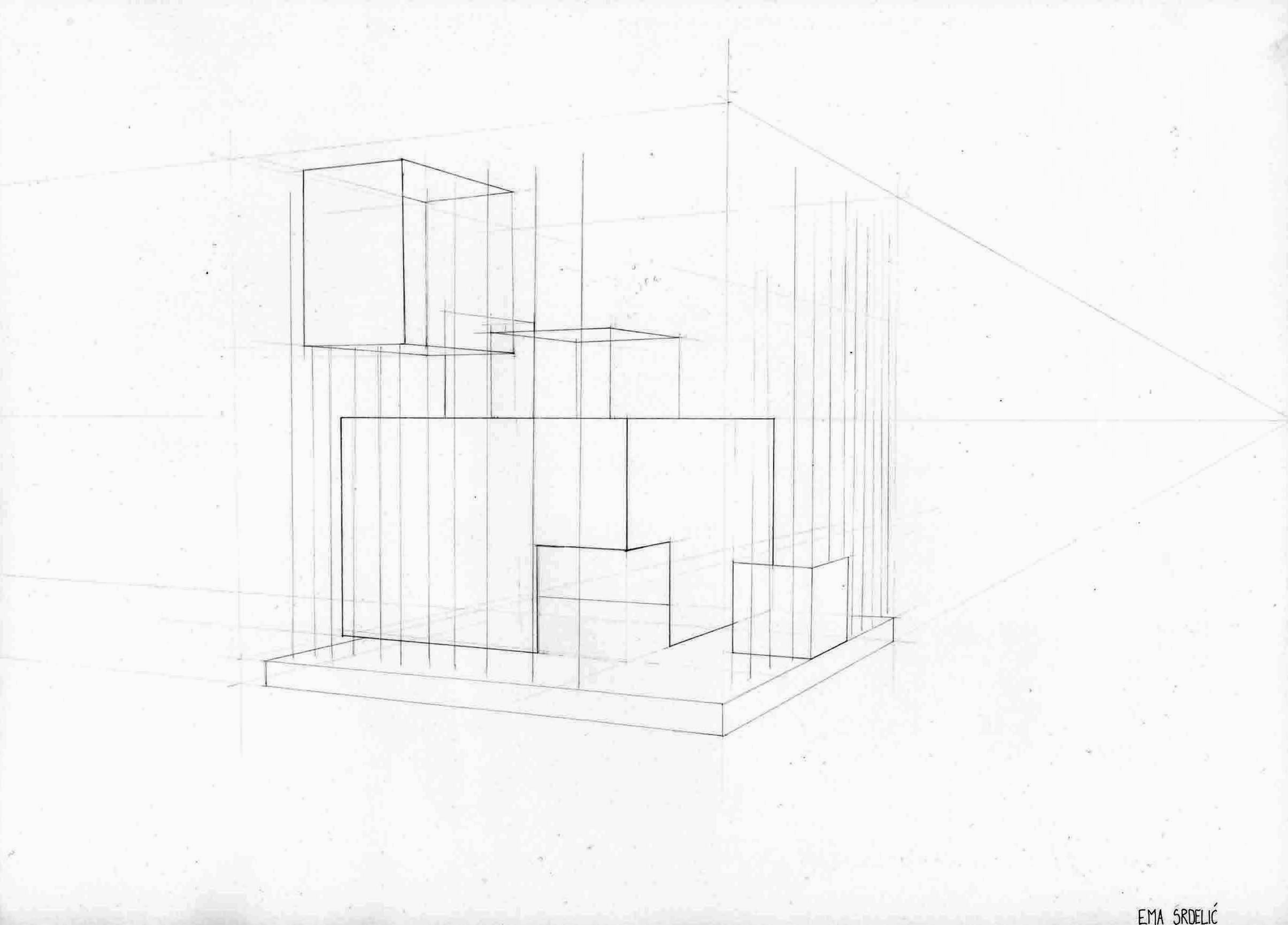

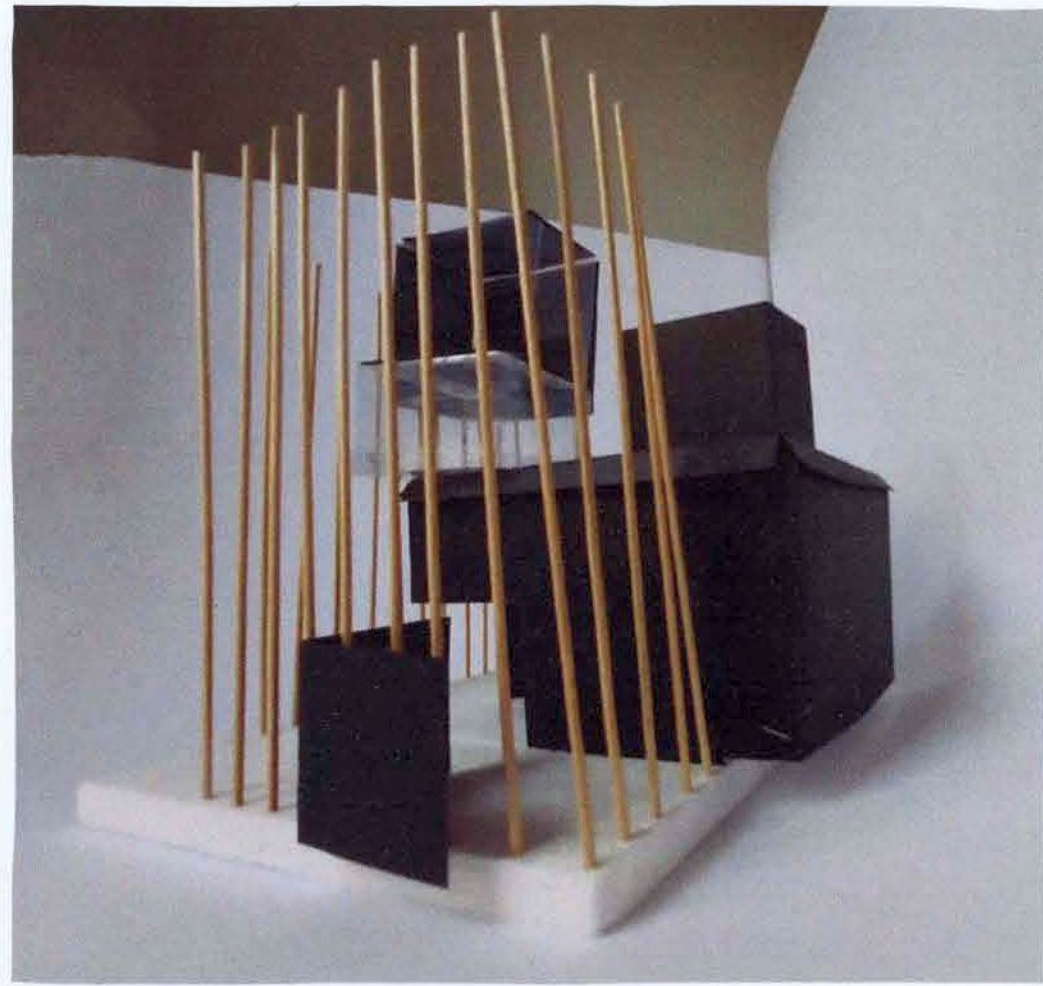
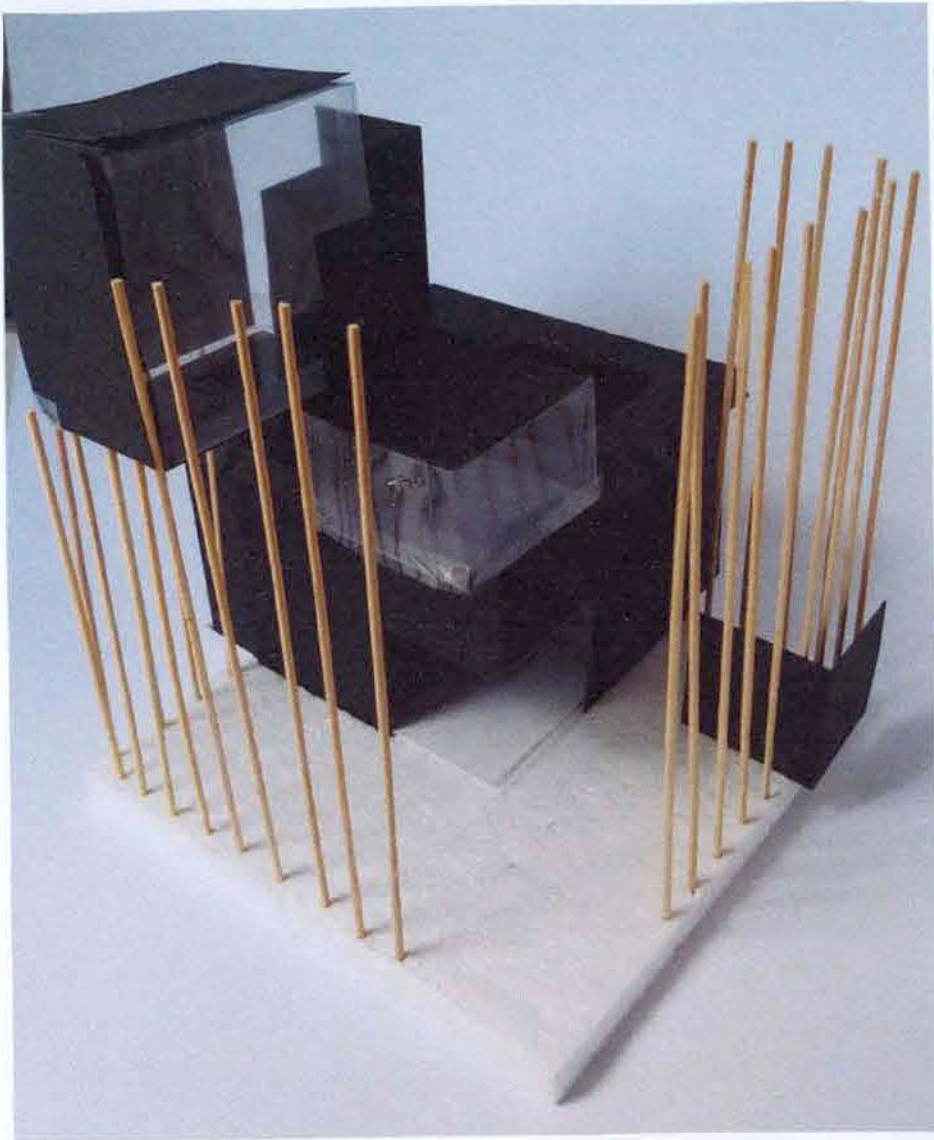

RADNA MAKETA

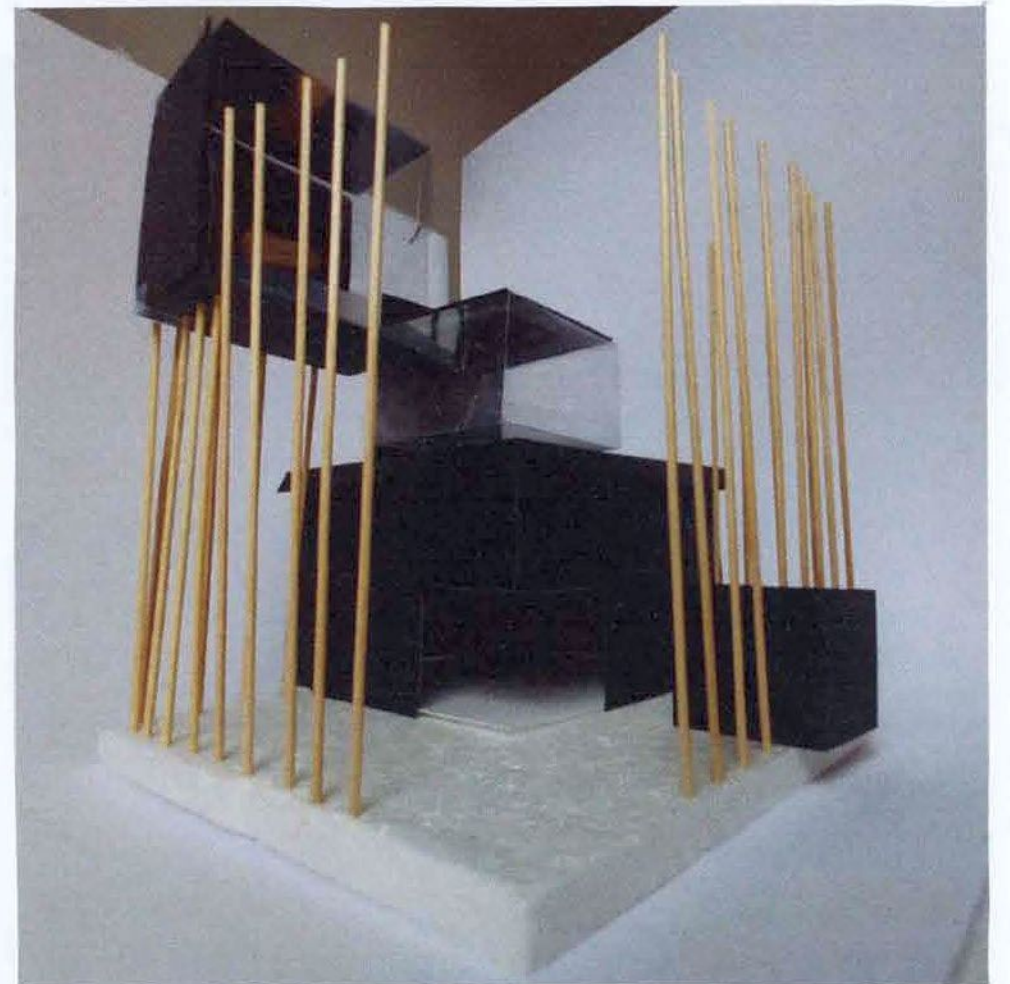
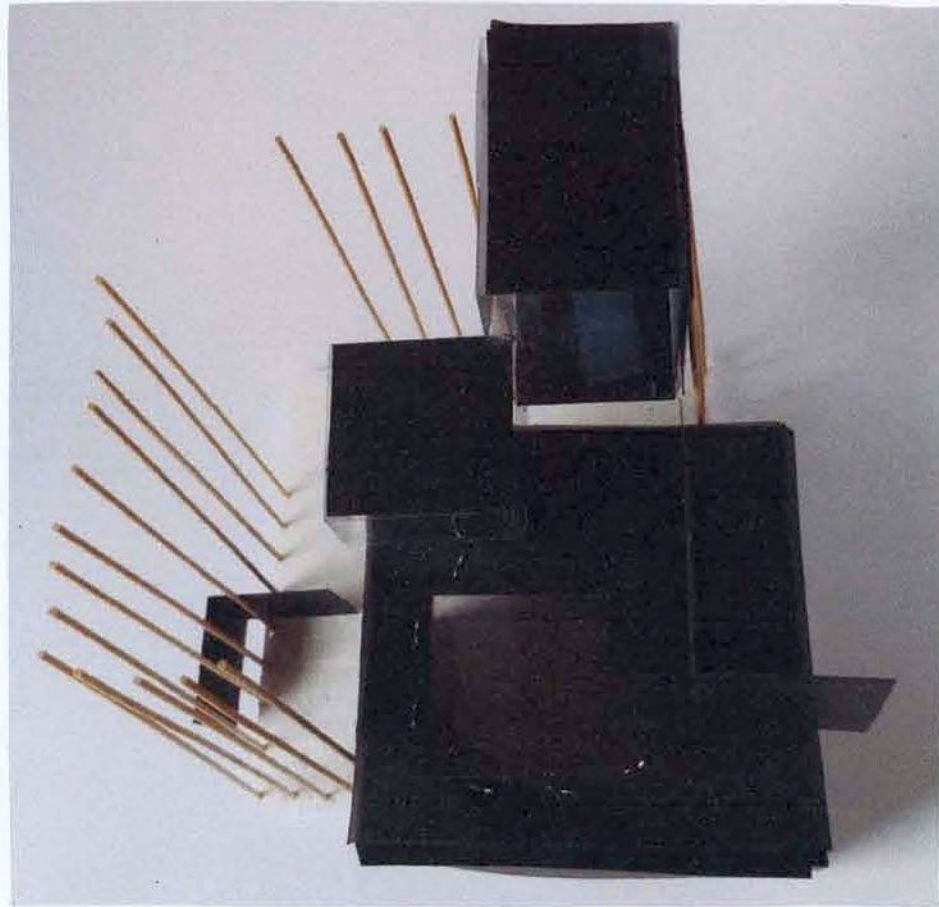

EMA SRDELIC

1. ETAŽA

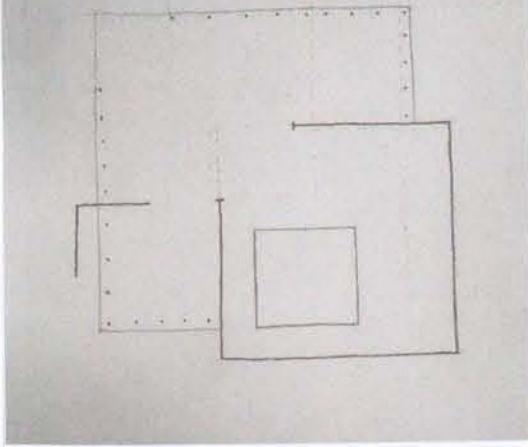

2. ETAŽA

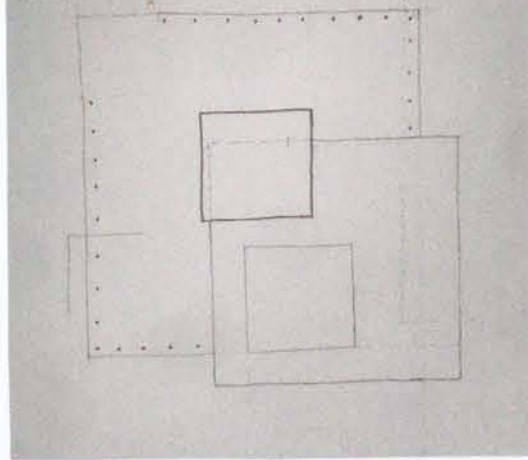

3. ETAŽA

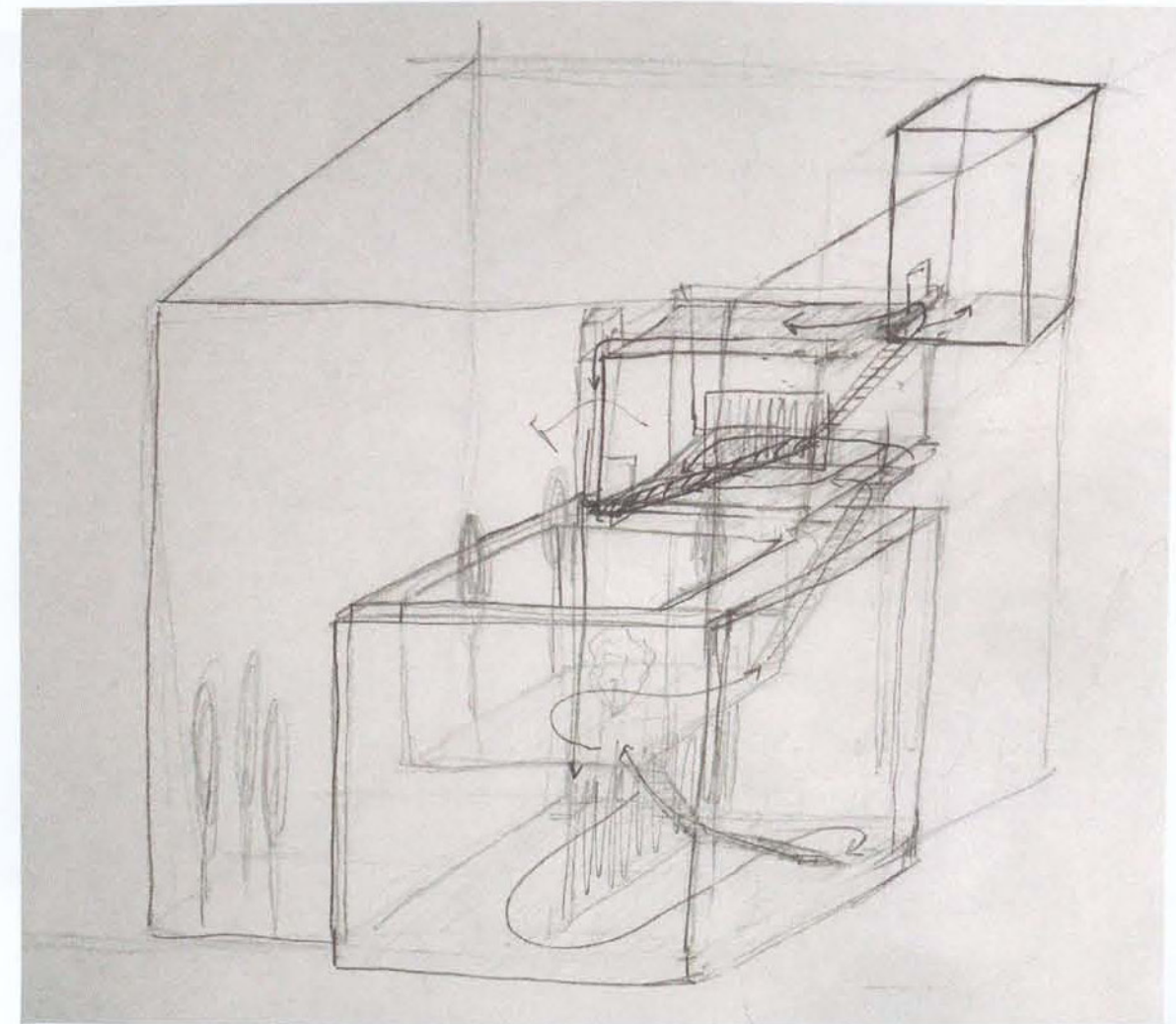
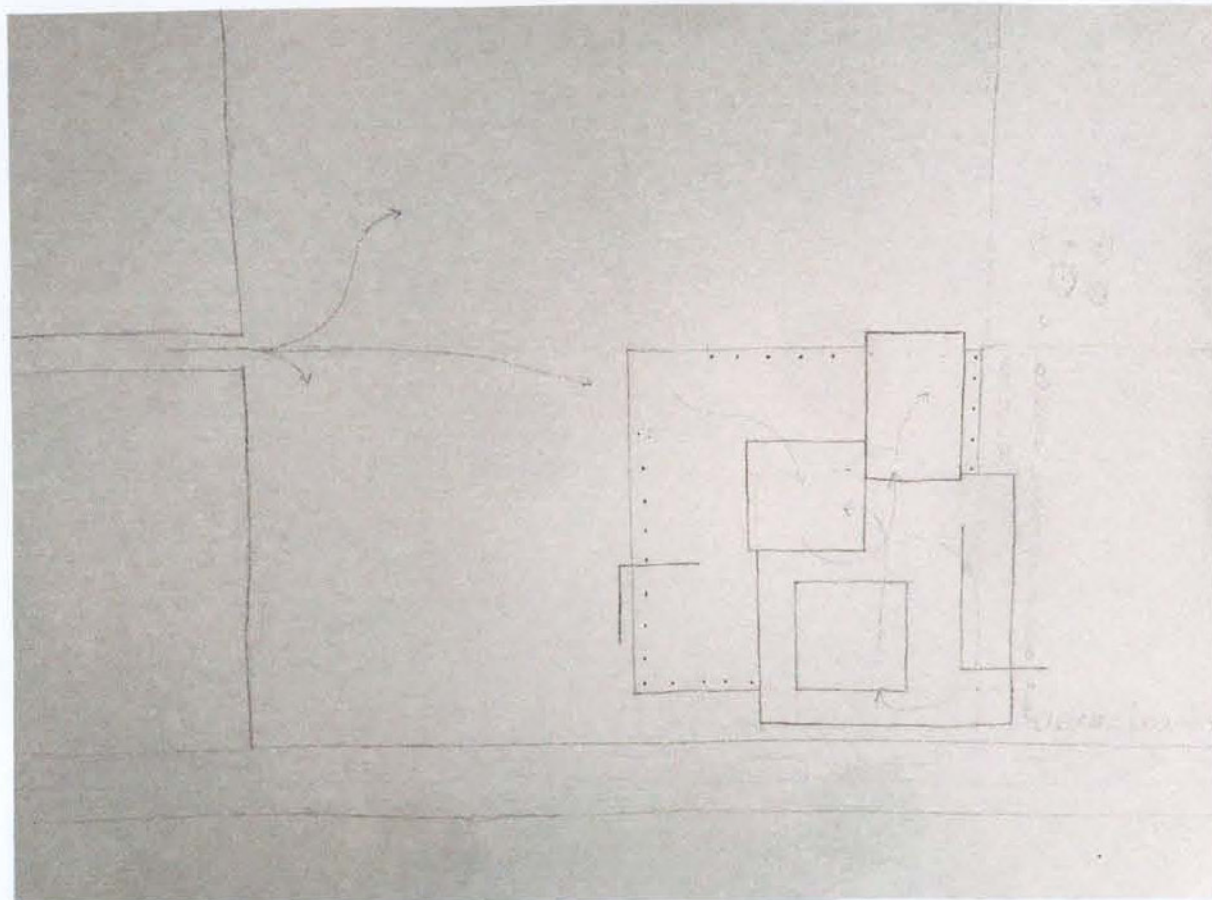
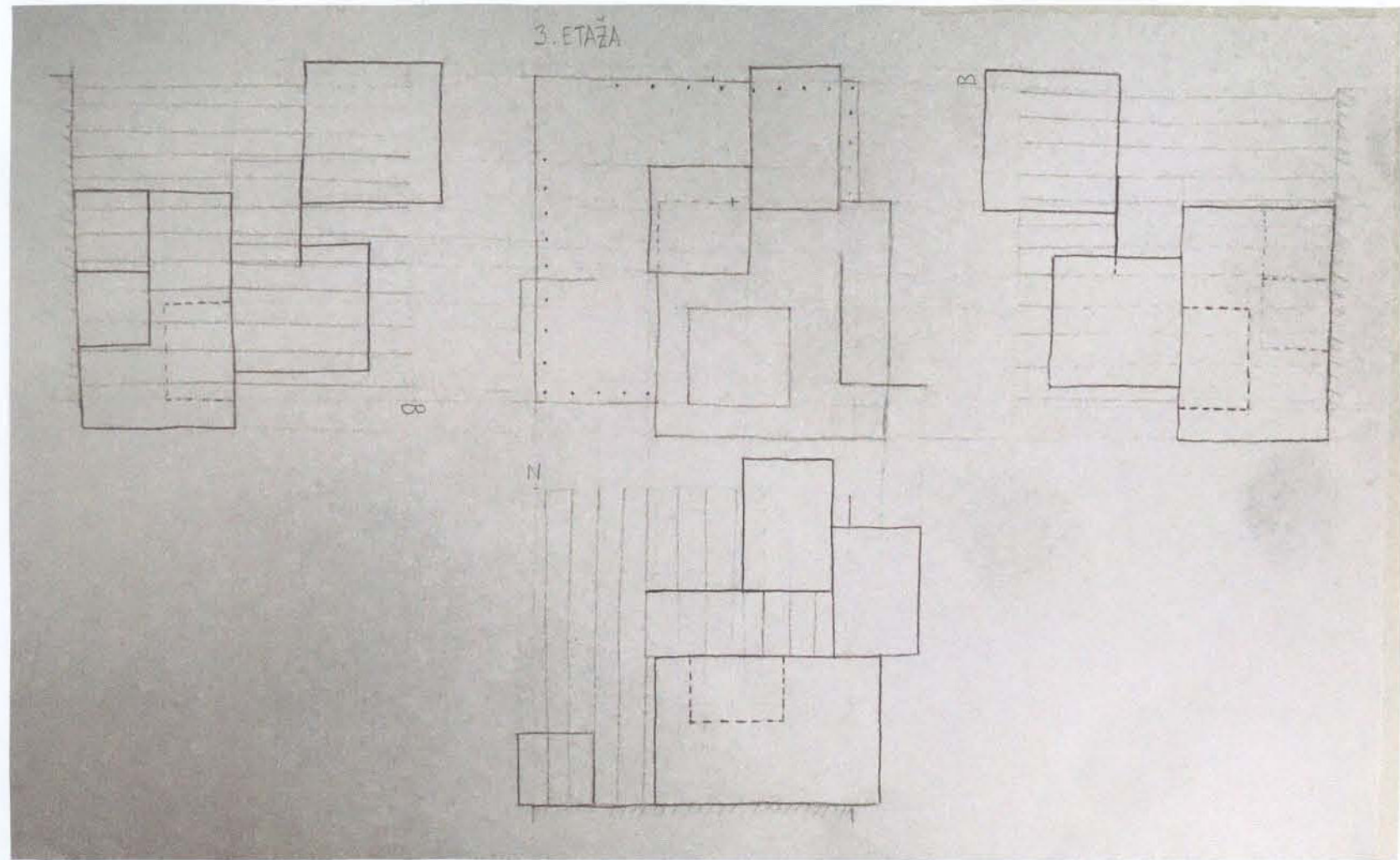

EMA SRDELIC

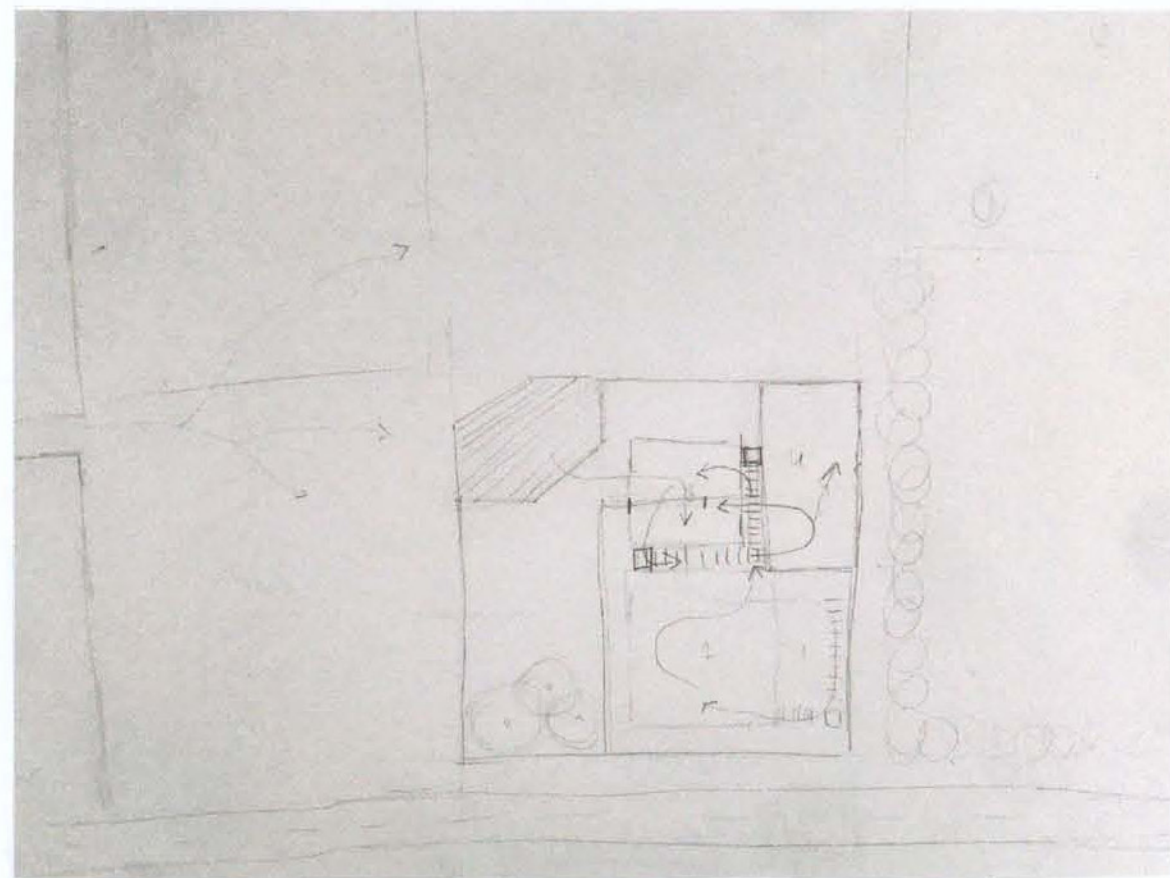
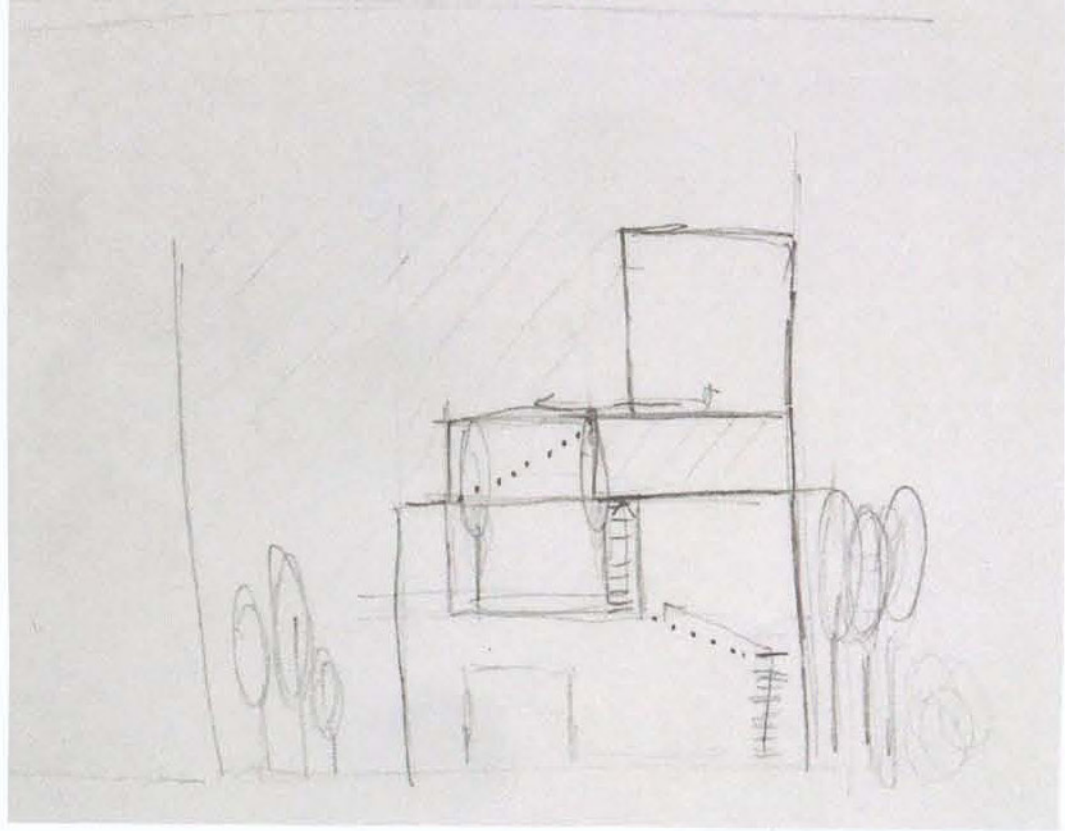
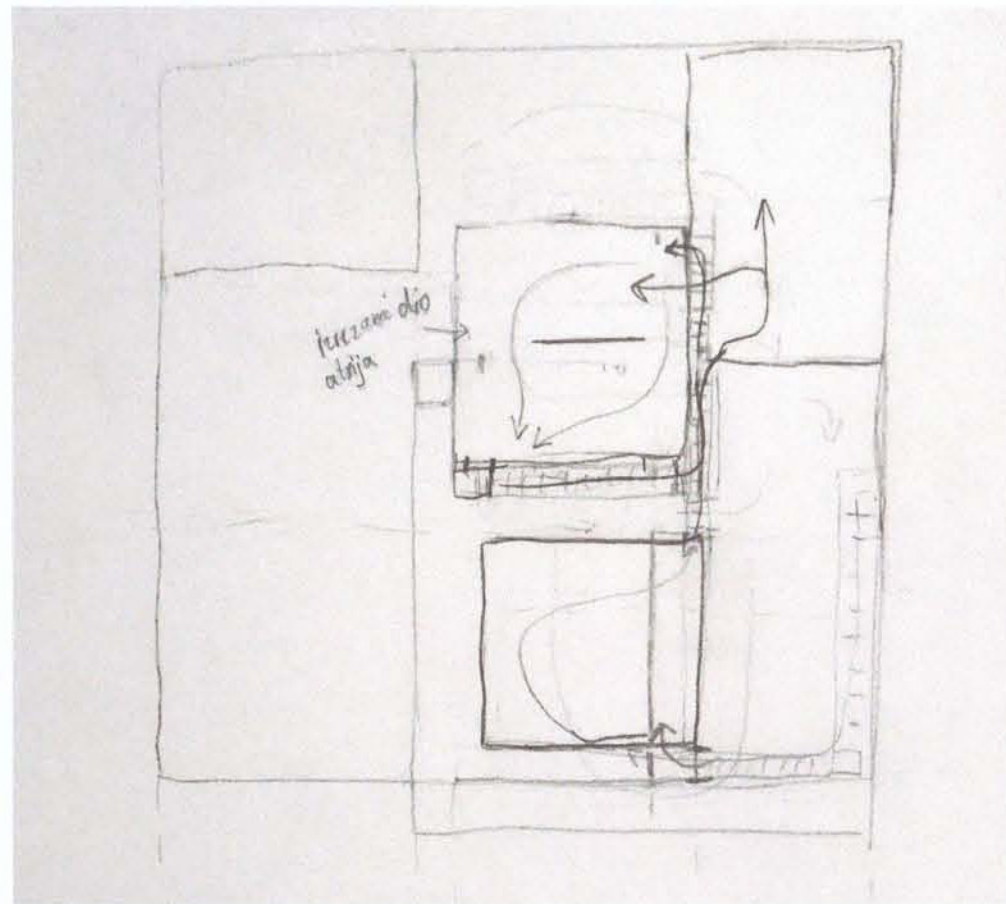
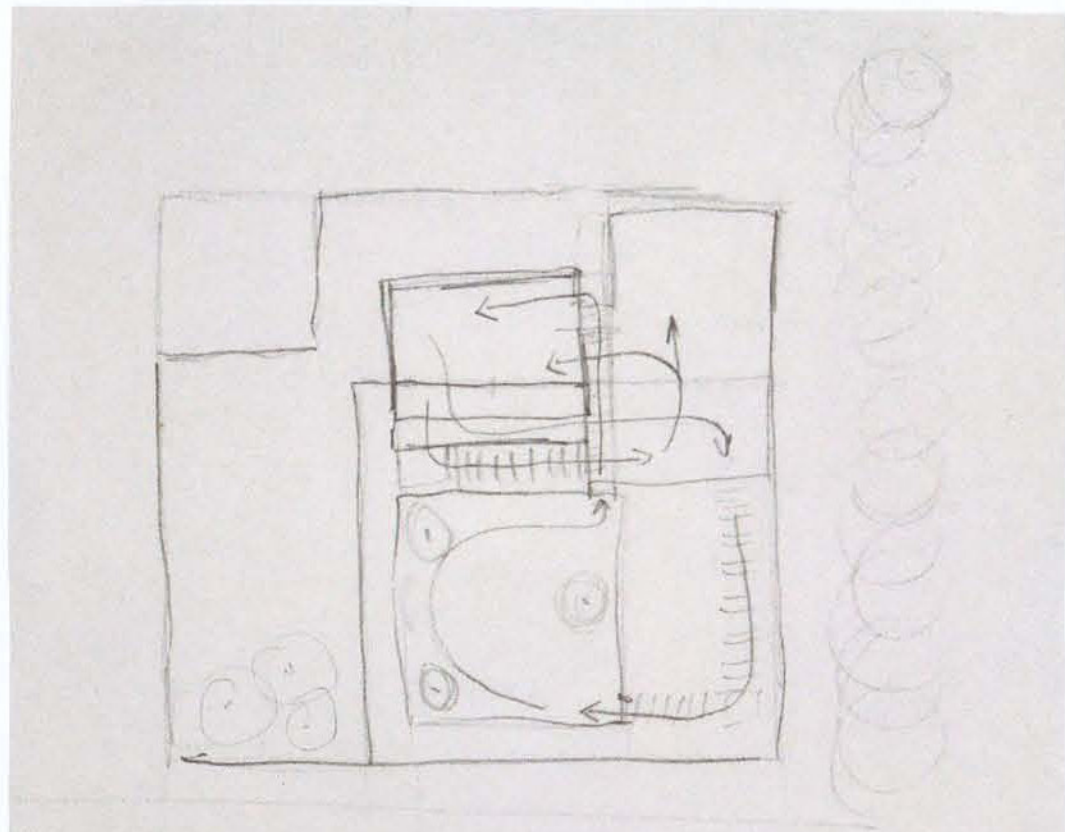

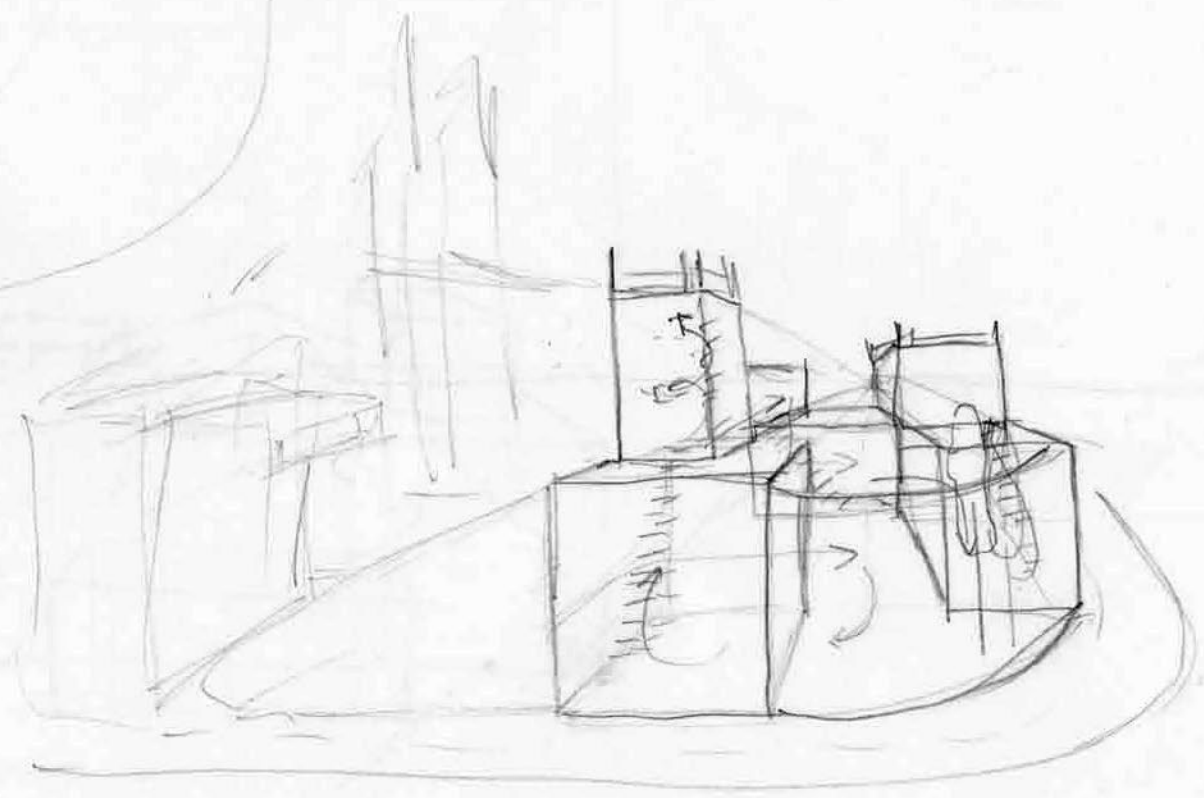
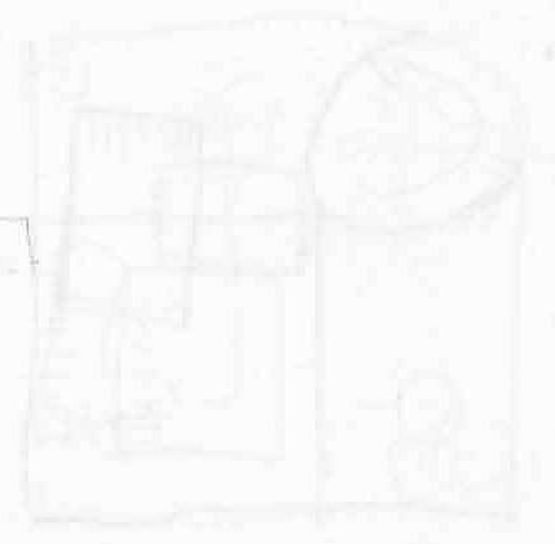
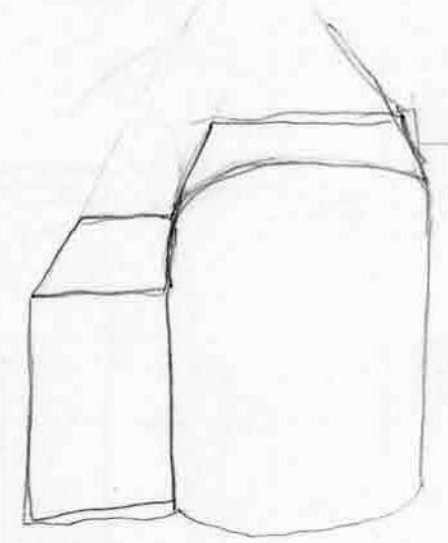
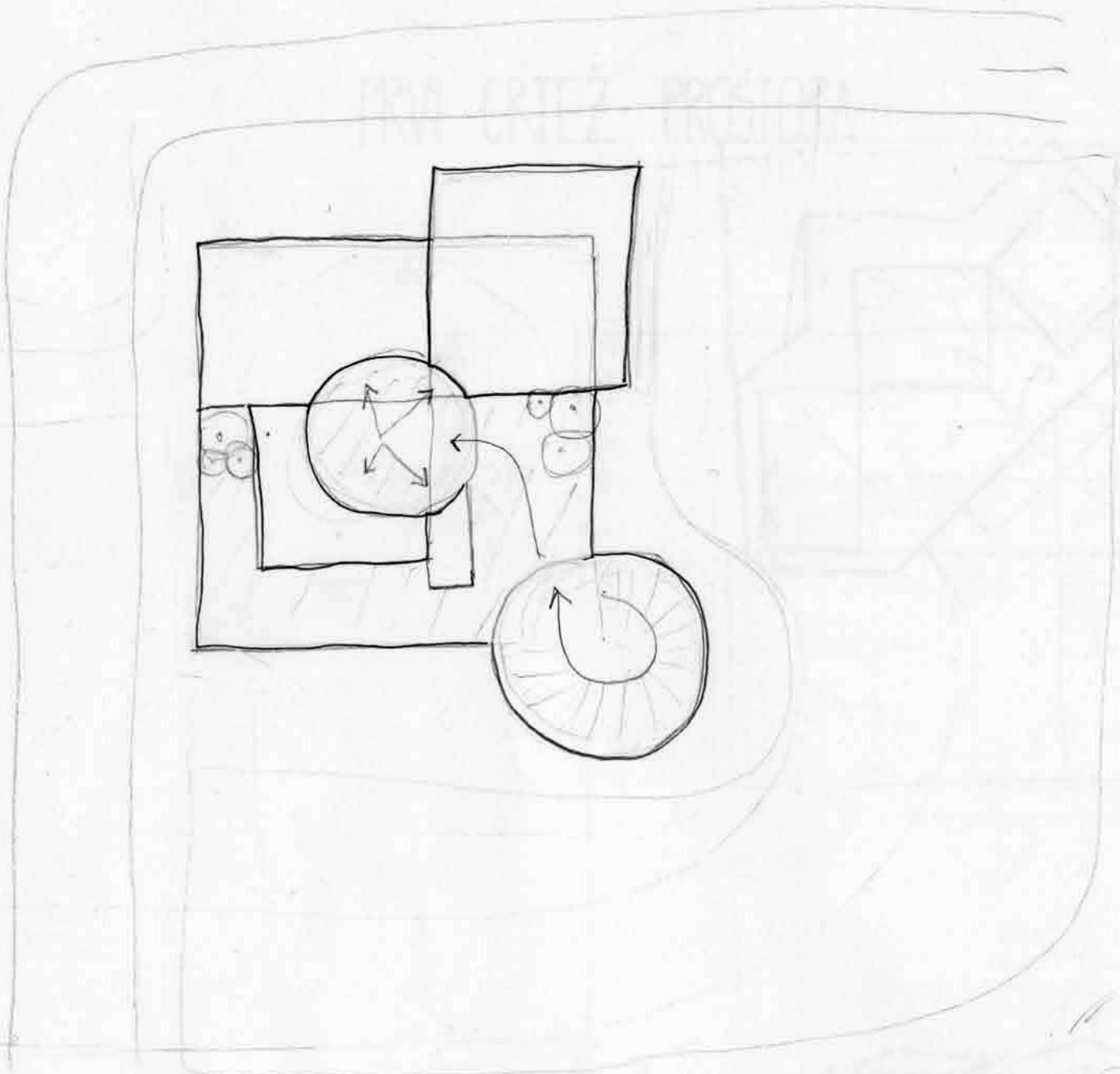

PRVI CRTEŽ PROSTORA

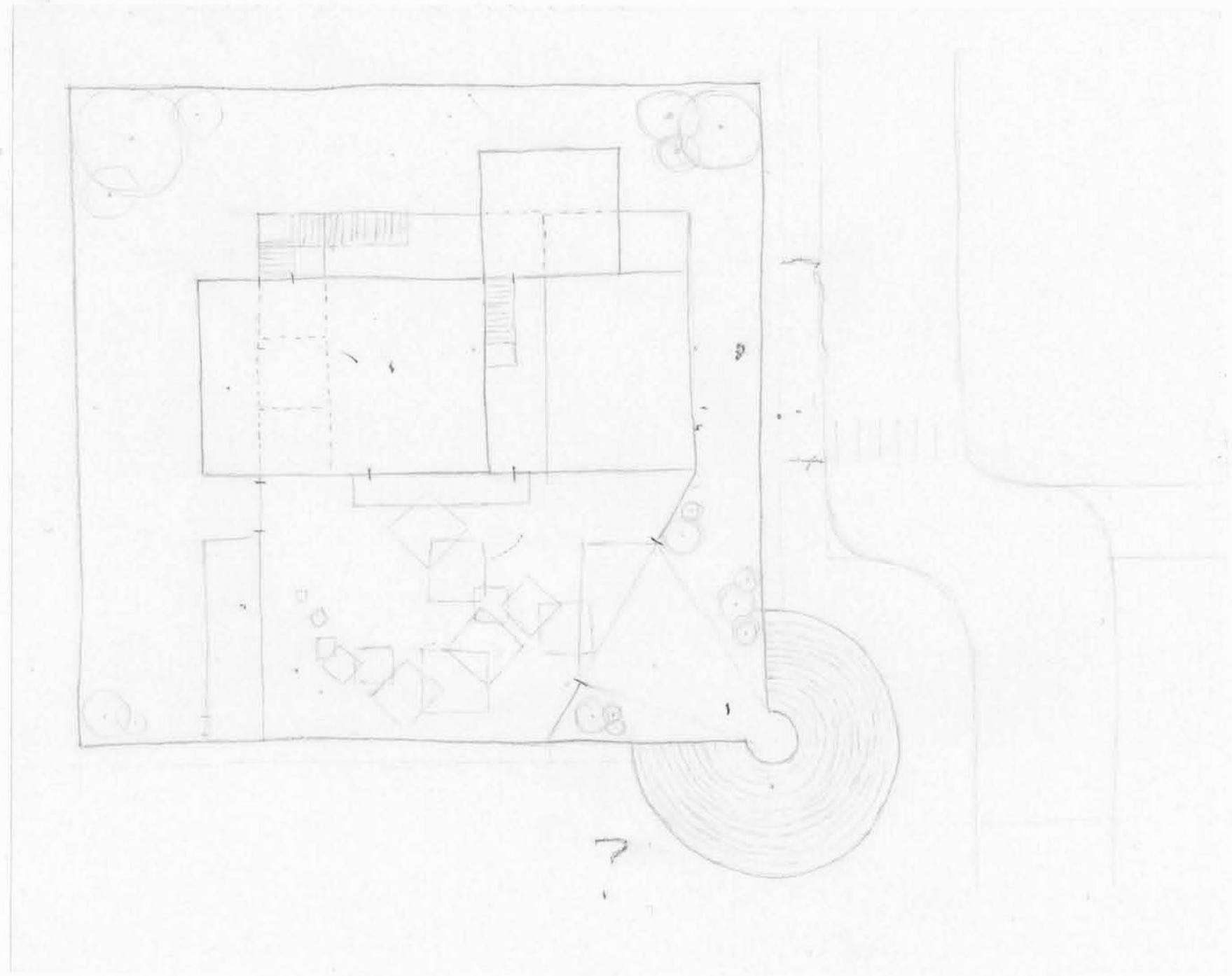

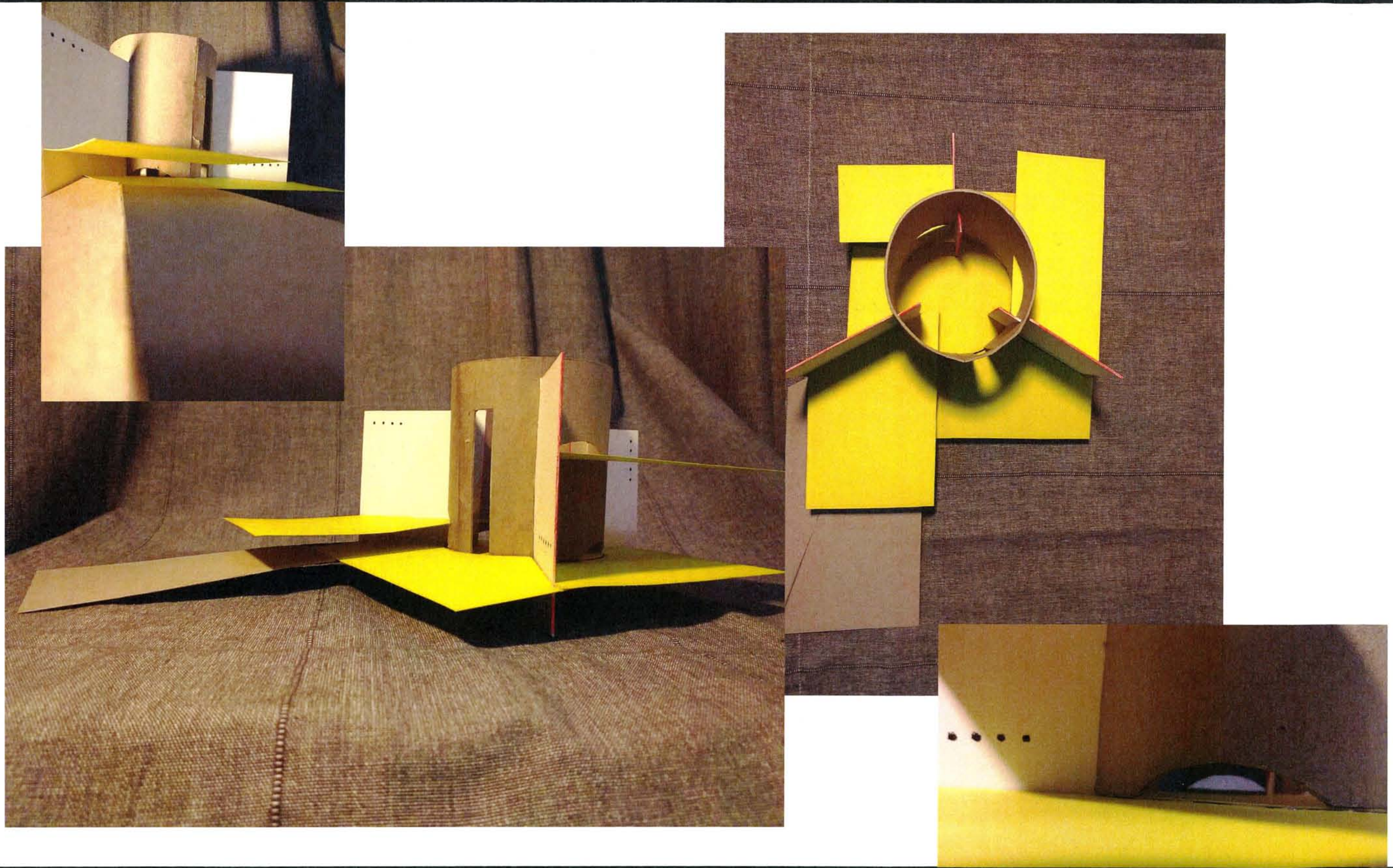

MENTORI

izv. prof. Stanko Stergaršek, di. i. a. // asistentica Aneta Mudronja Pletenac, d. i. a.

ANDRIJA RUDAK — Krajobrazna arhitektura, 1. semestar BS, 2020/2021

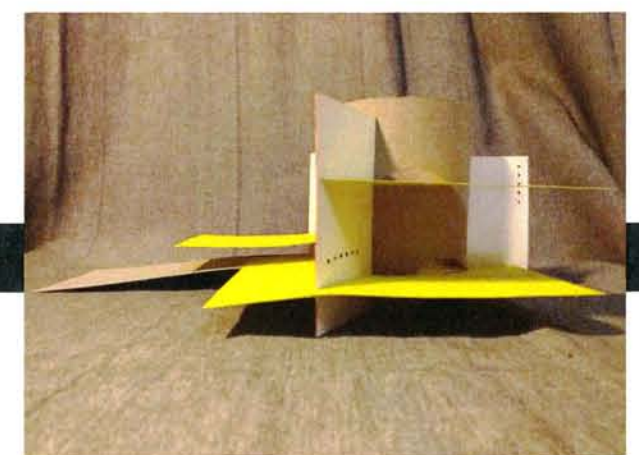
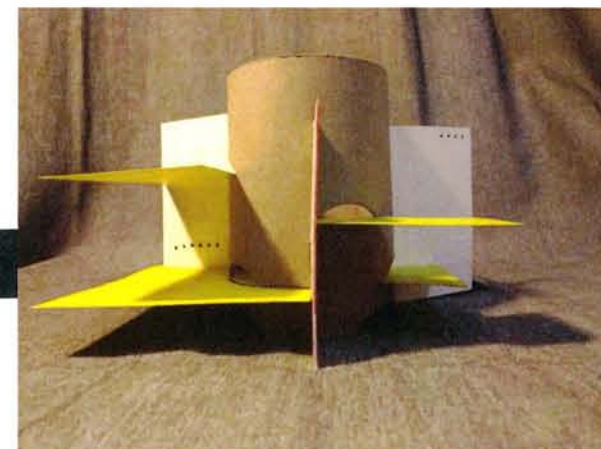
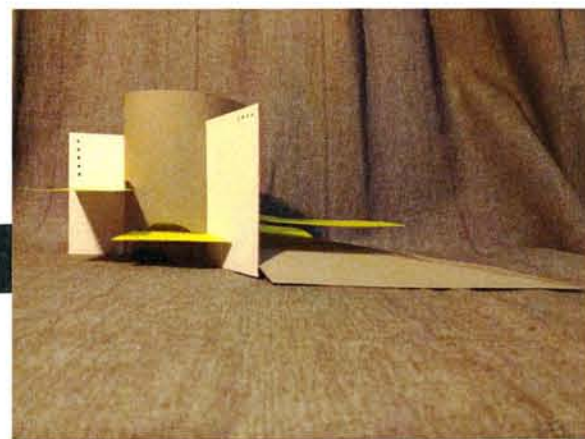
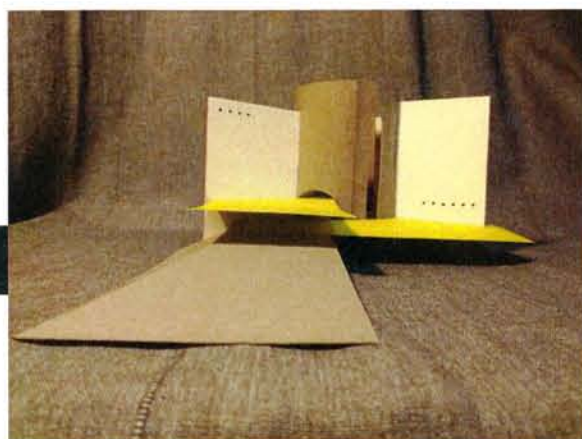
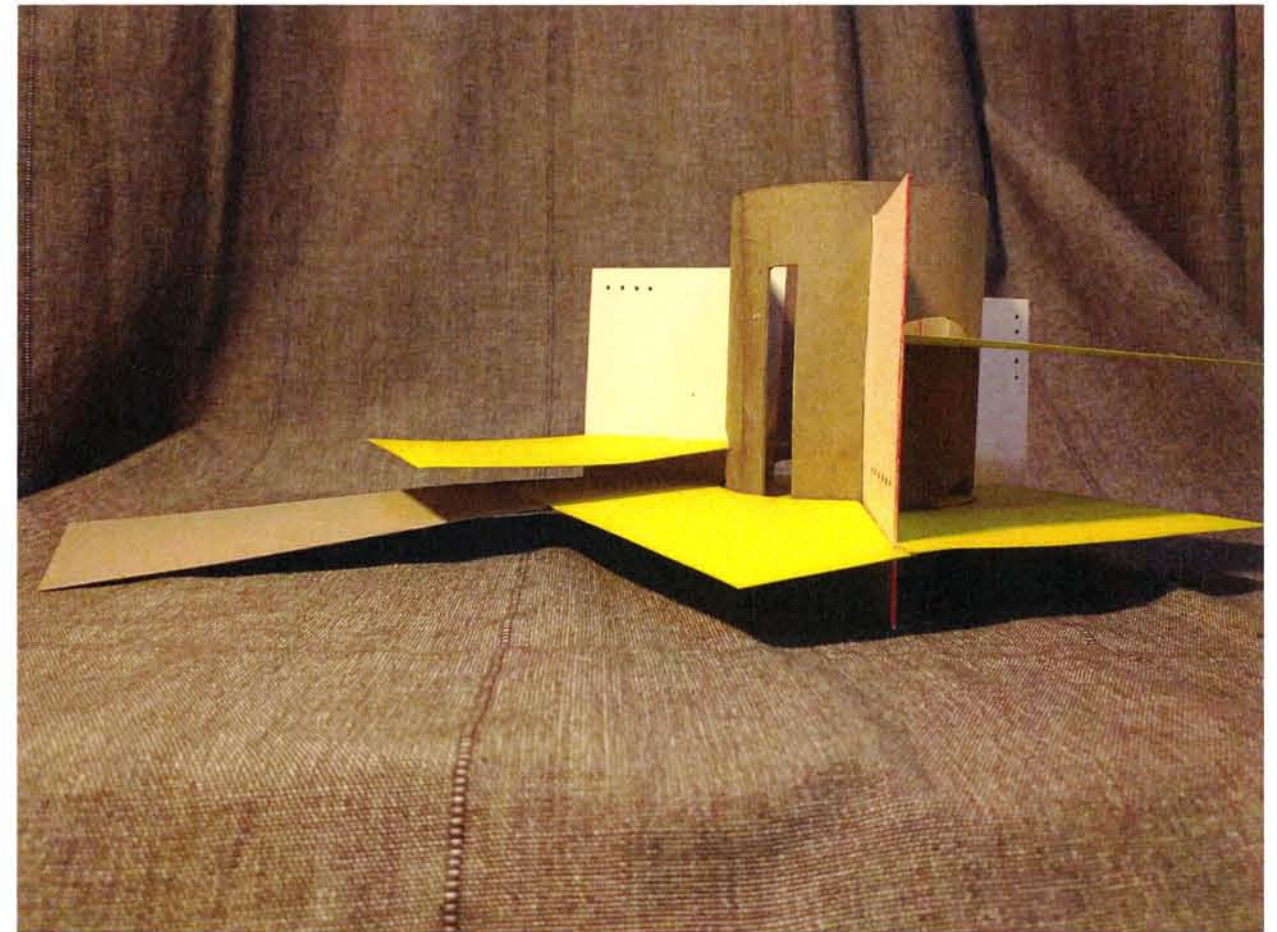
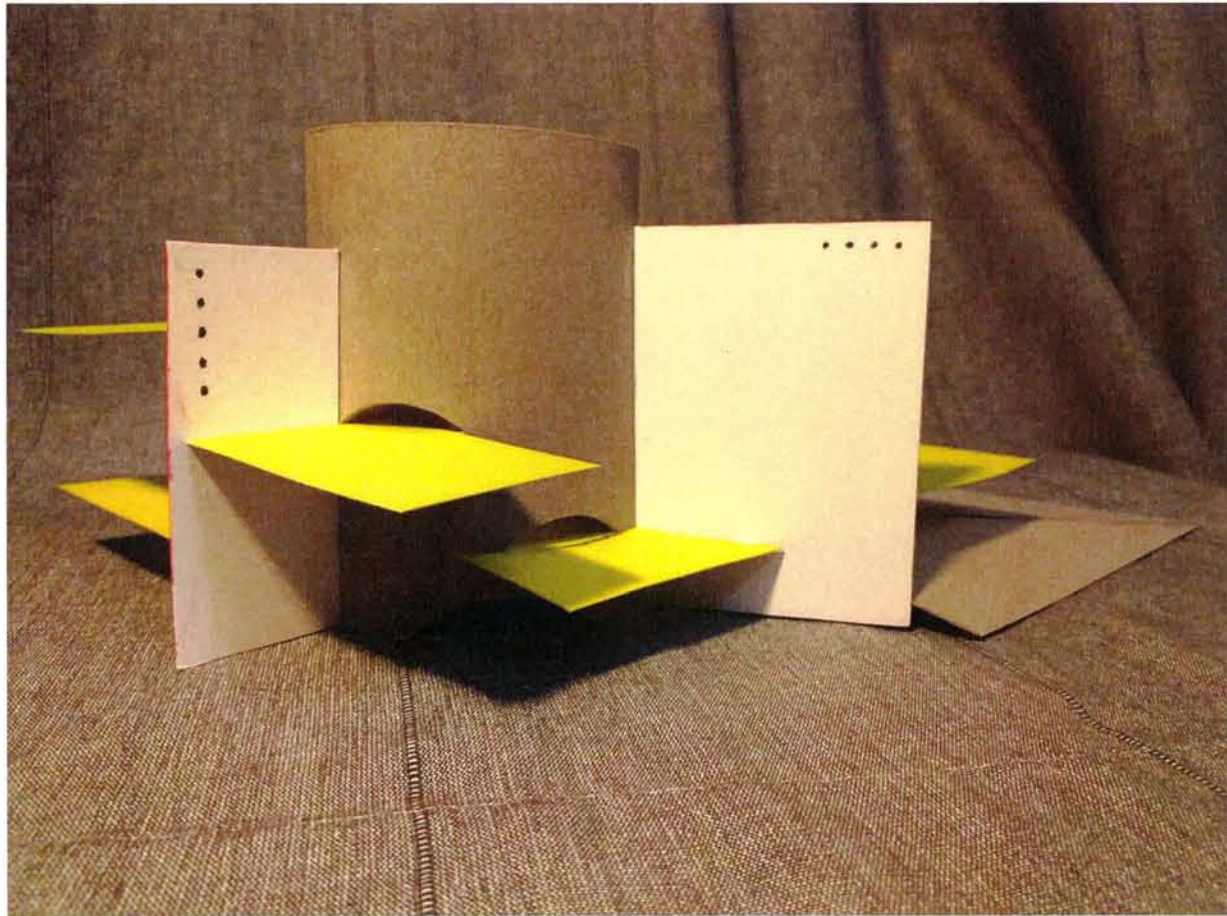

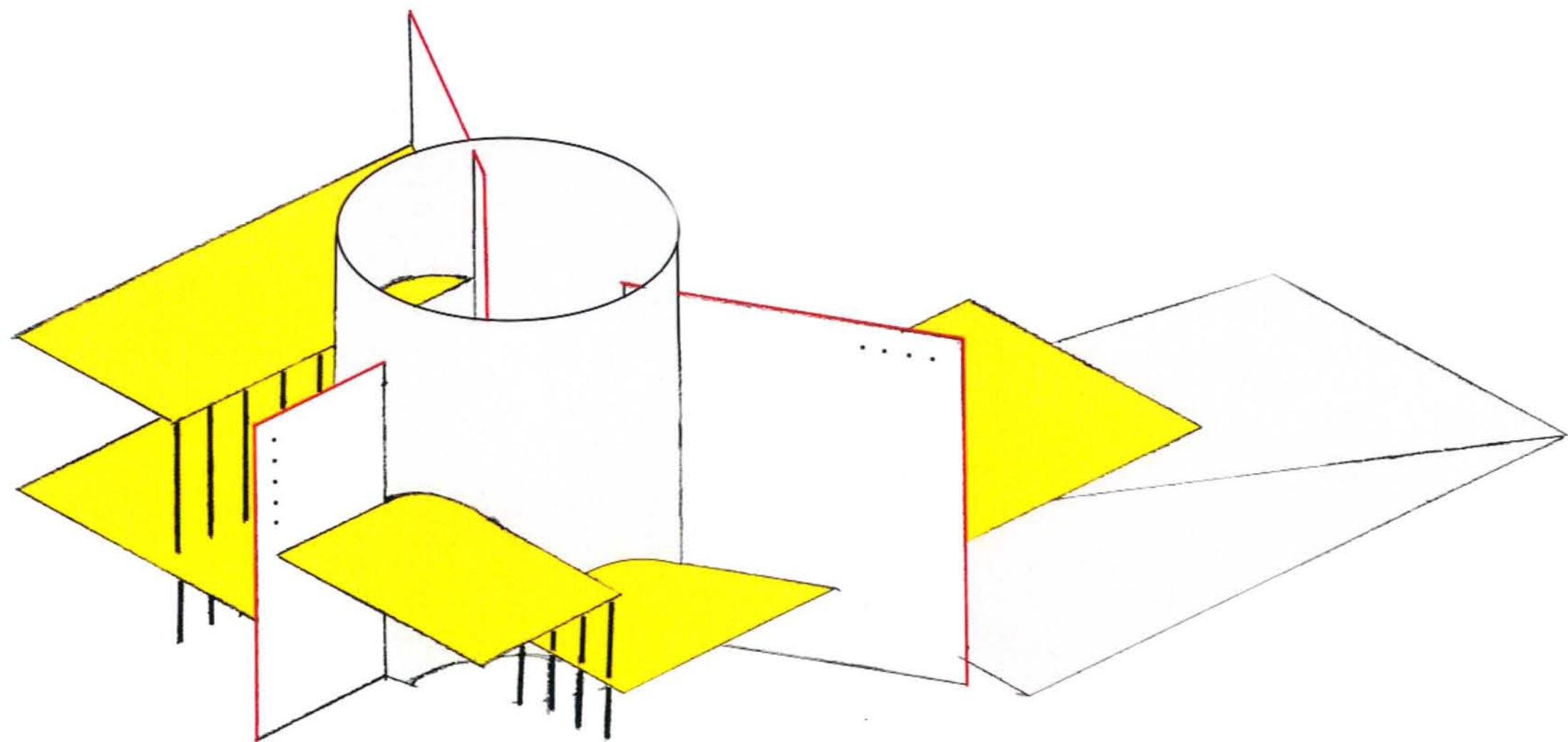

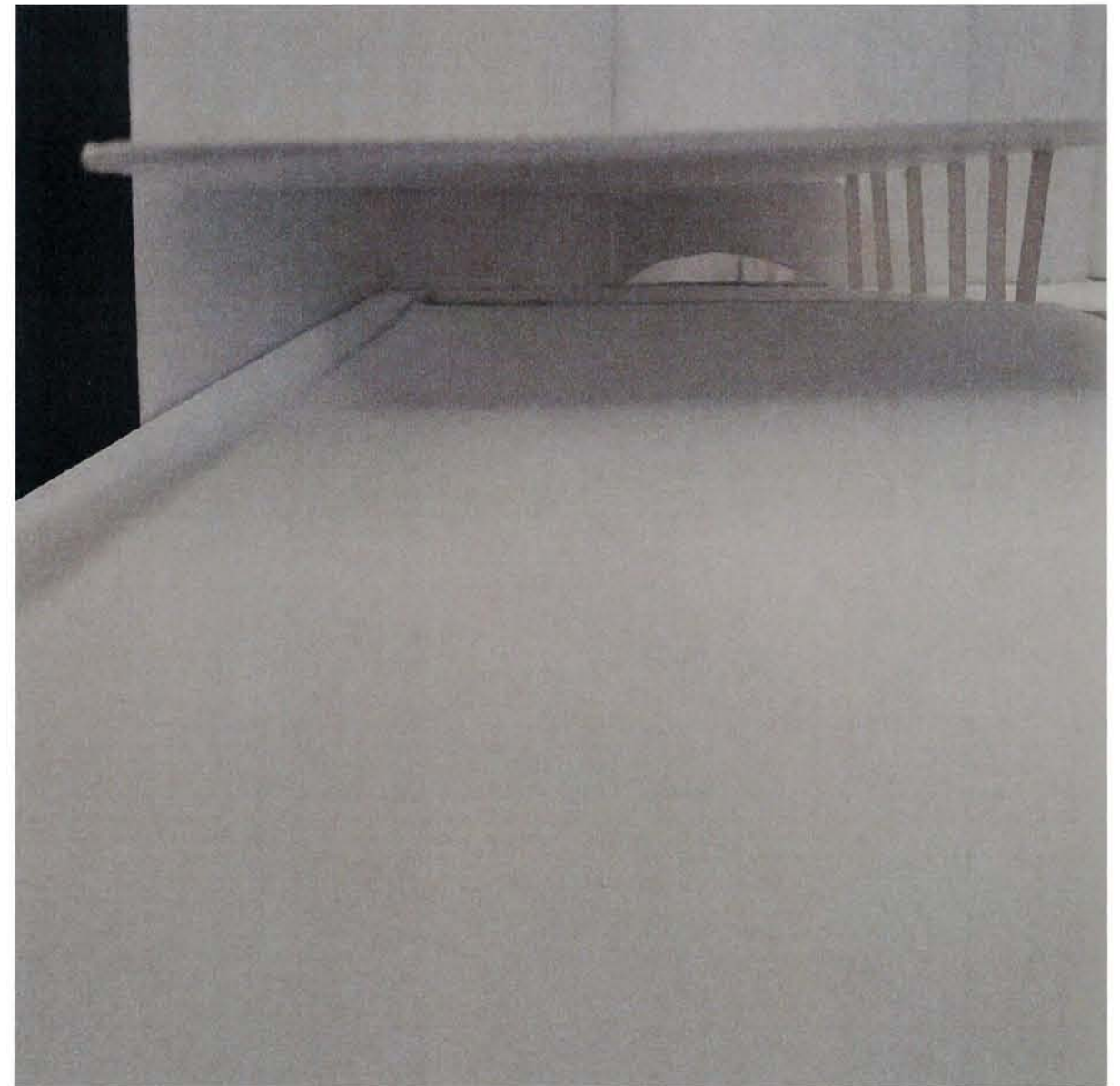
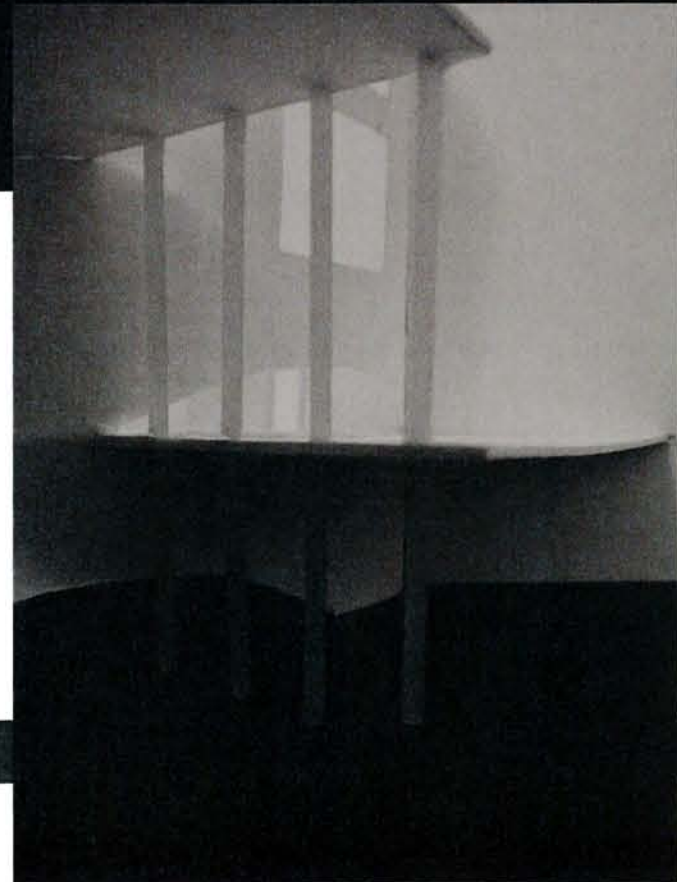
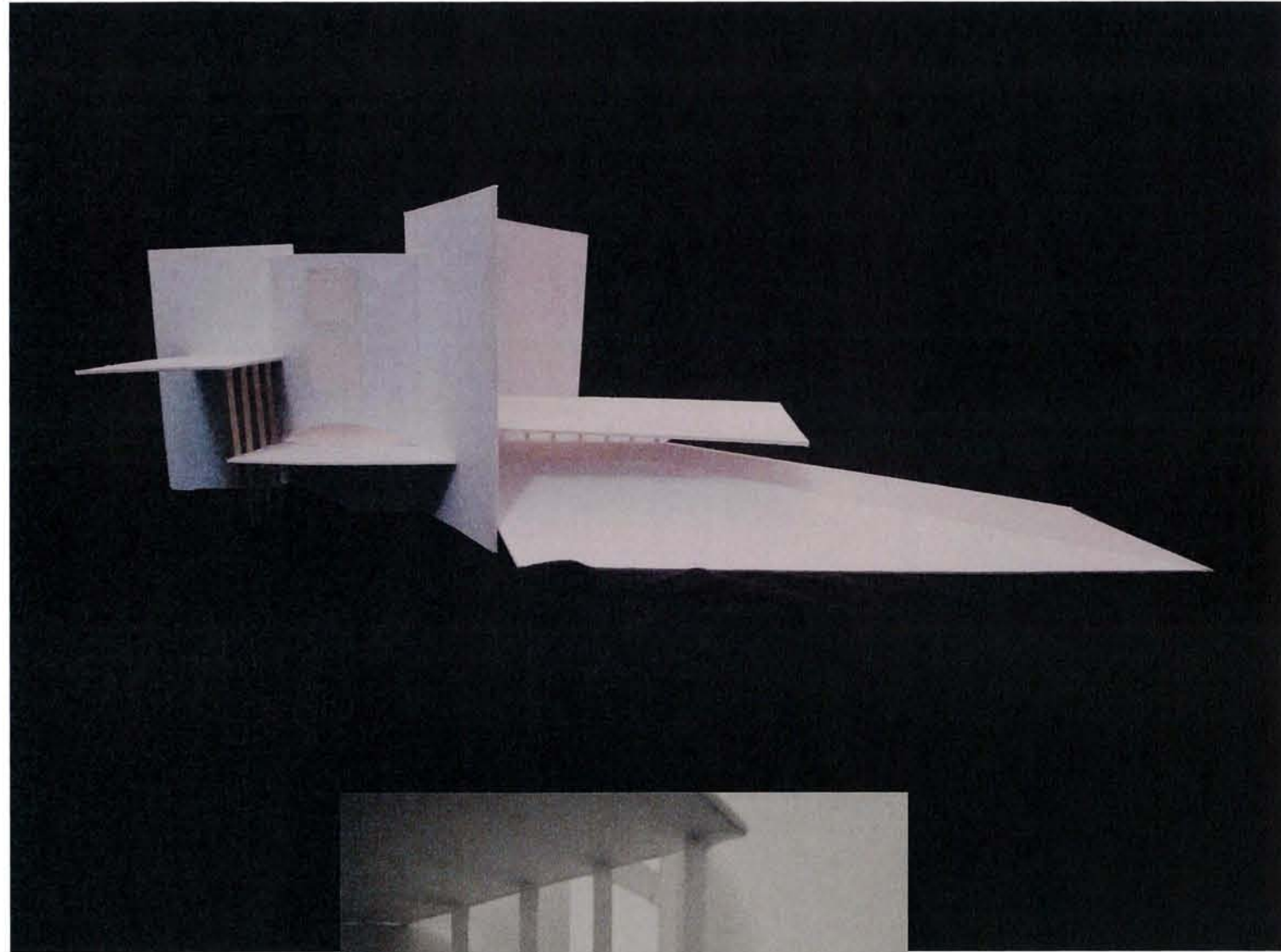

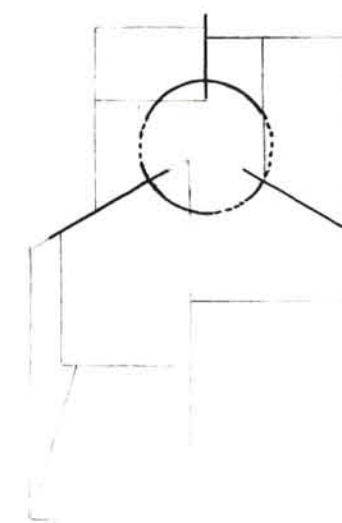
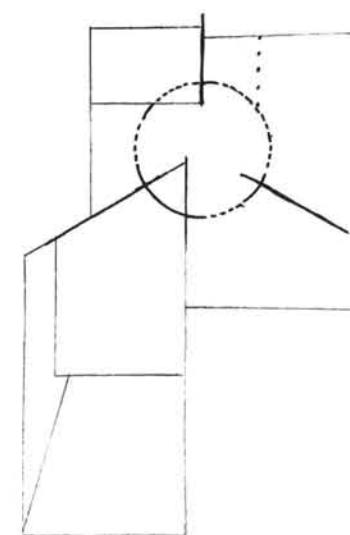
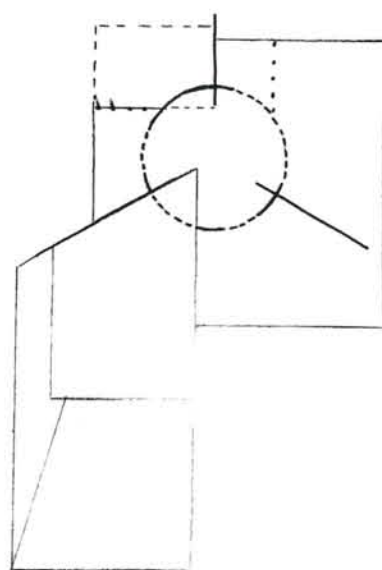
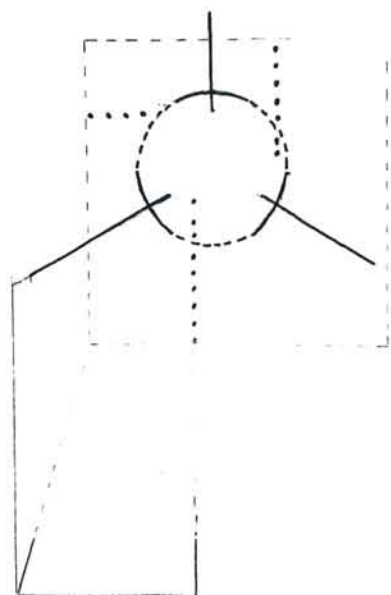
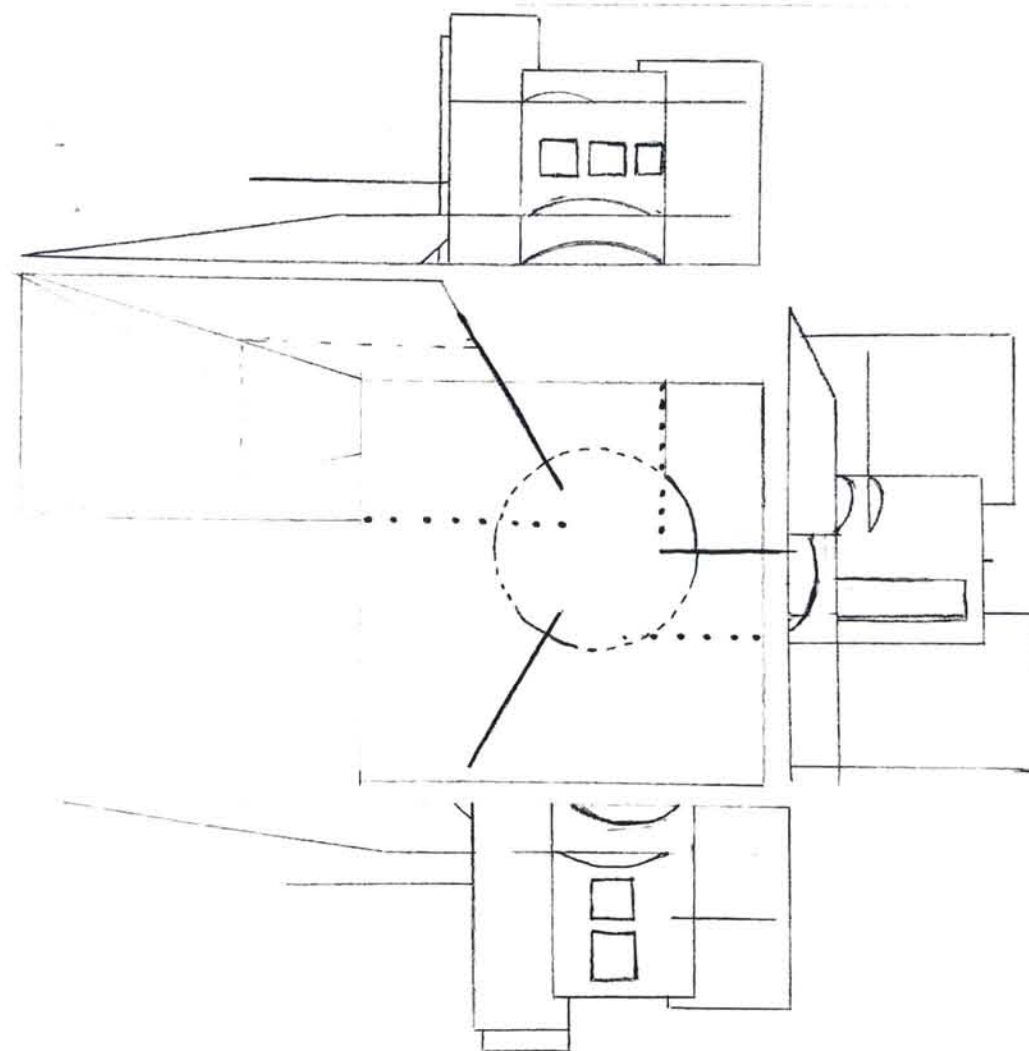

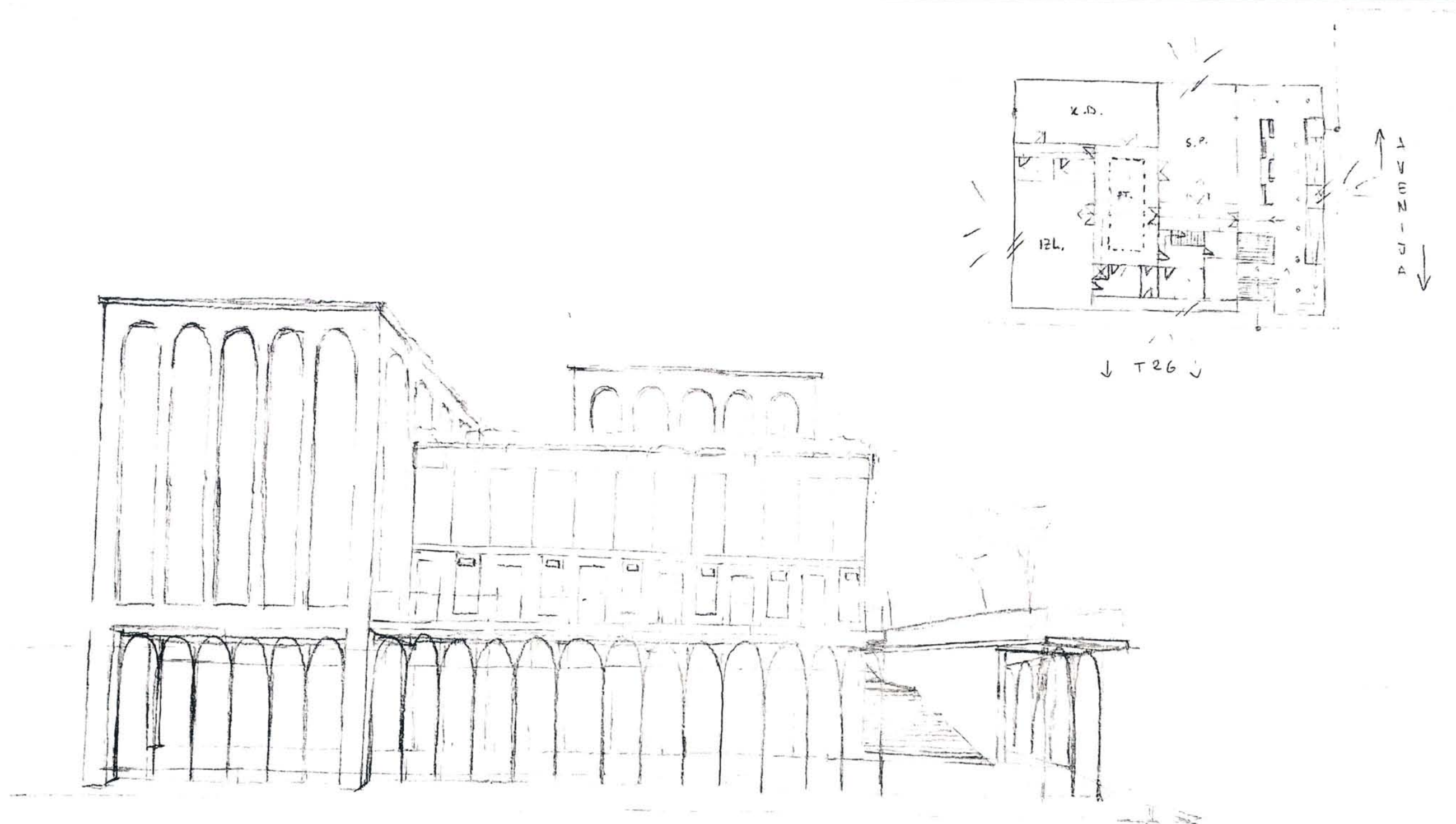

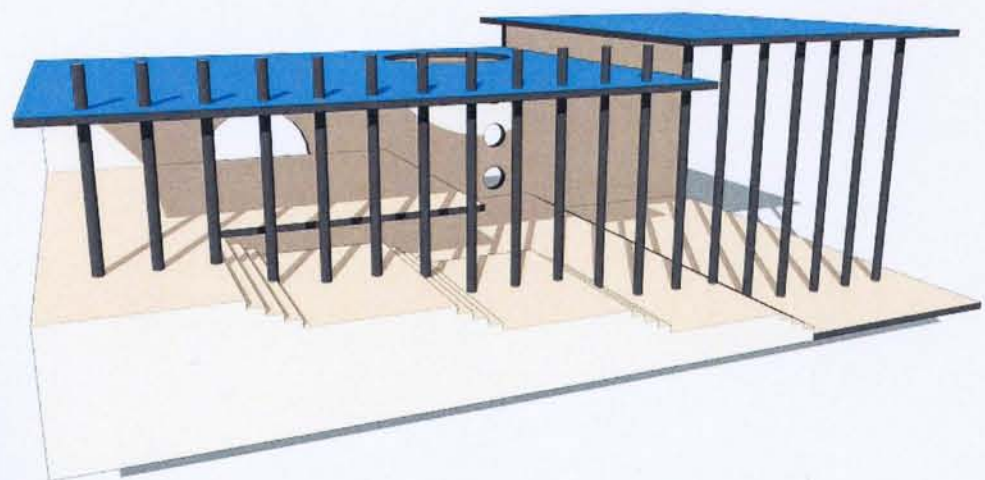
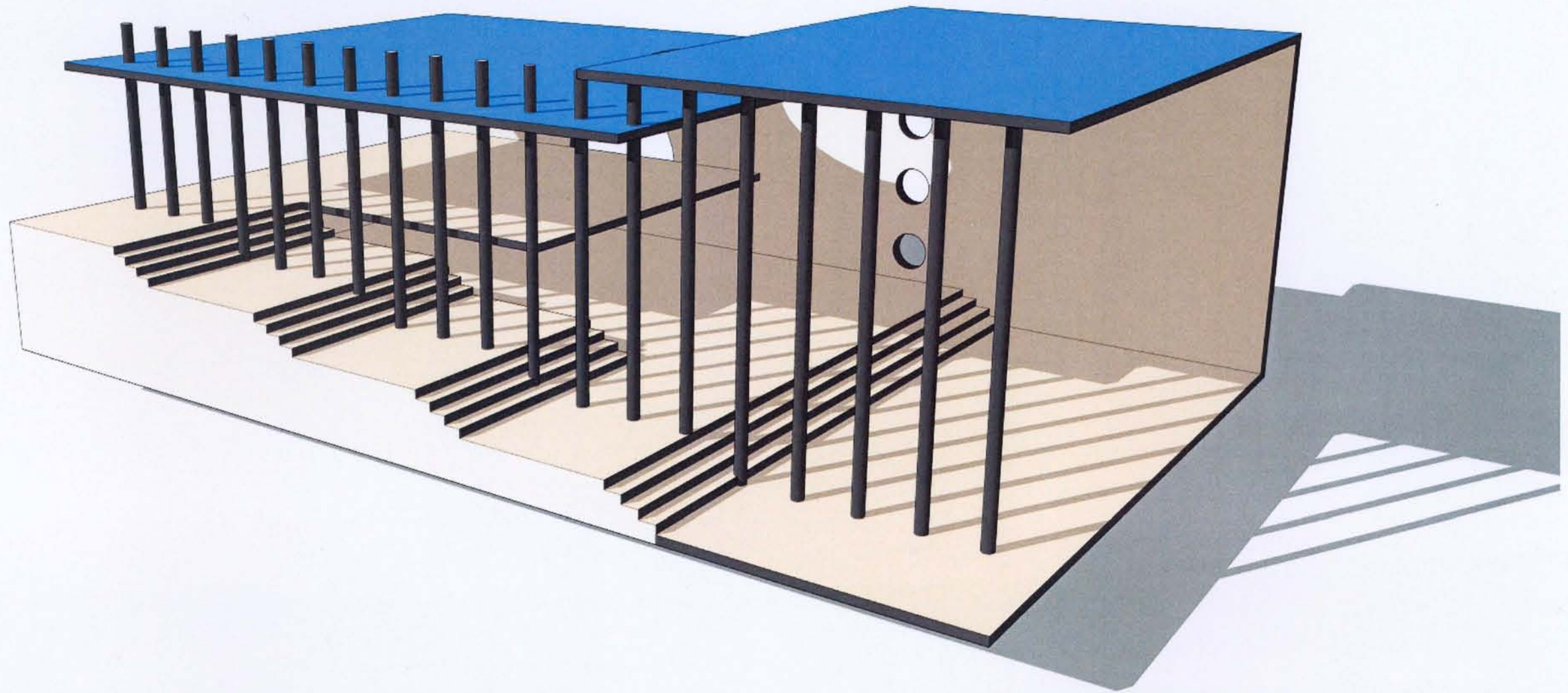

FILIP MOROŽIN

Osnove arhitektonskog projektiranja
Mentori: izv. prof. art. Stanko Stergaršek, d.i.a;
asistent Aneta Mudronja Pletenac, d.i.a.
Studij: Krajobrazna arhitektura - 1. semestar Bs
Ak. god. 2020/21.

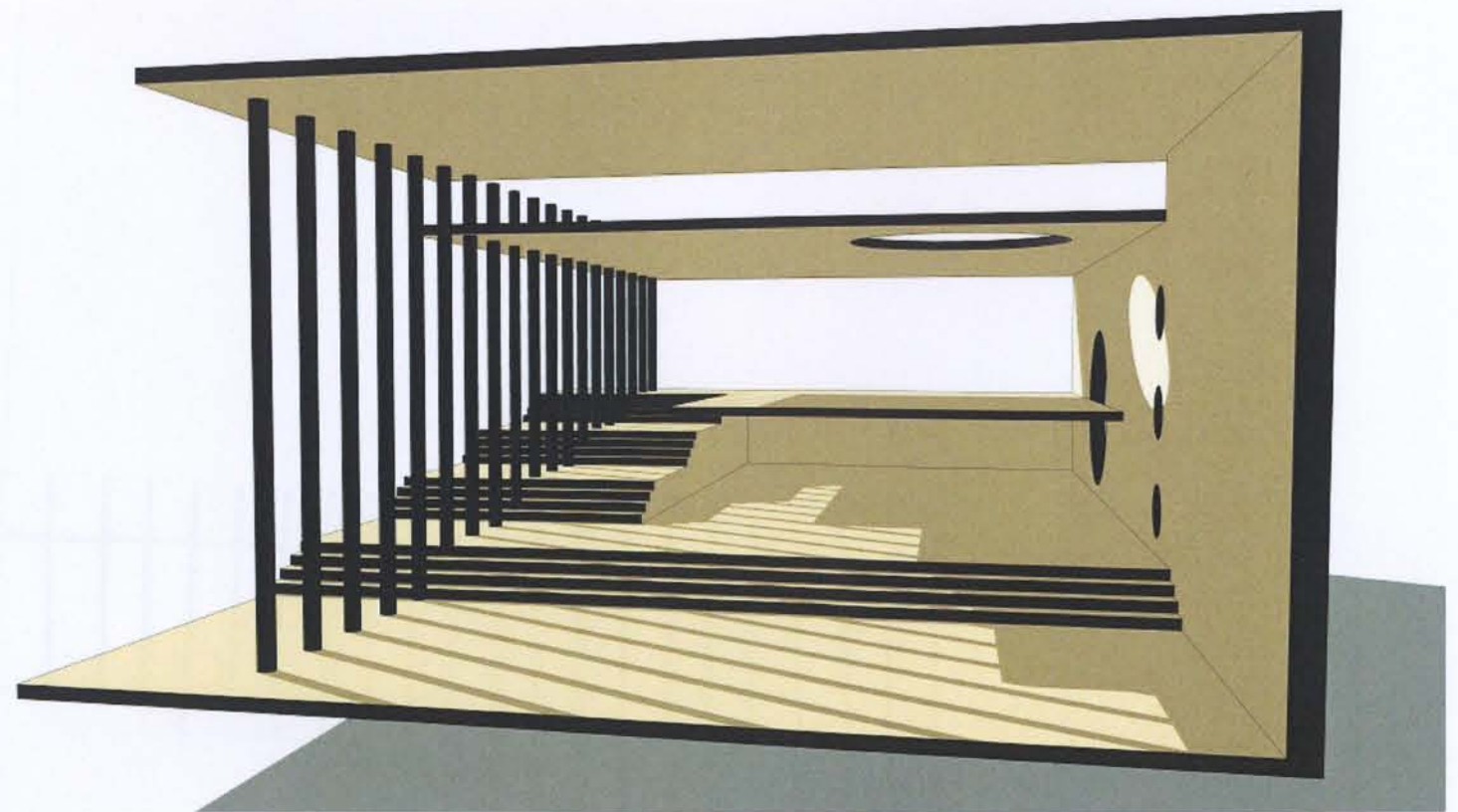
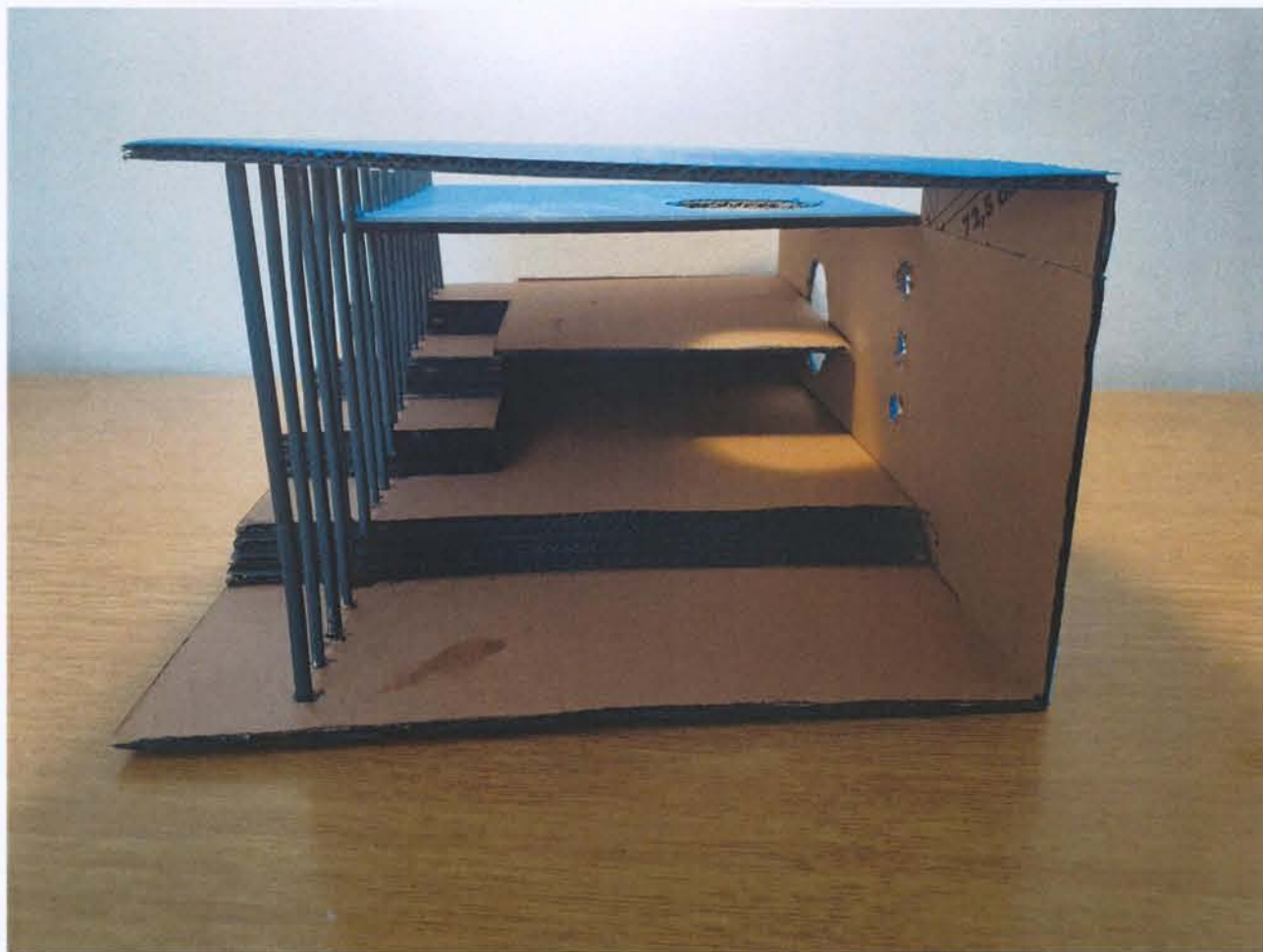
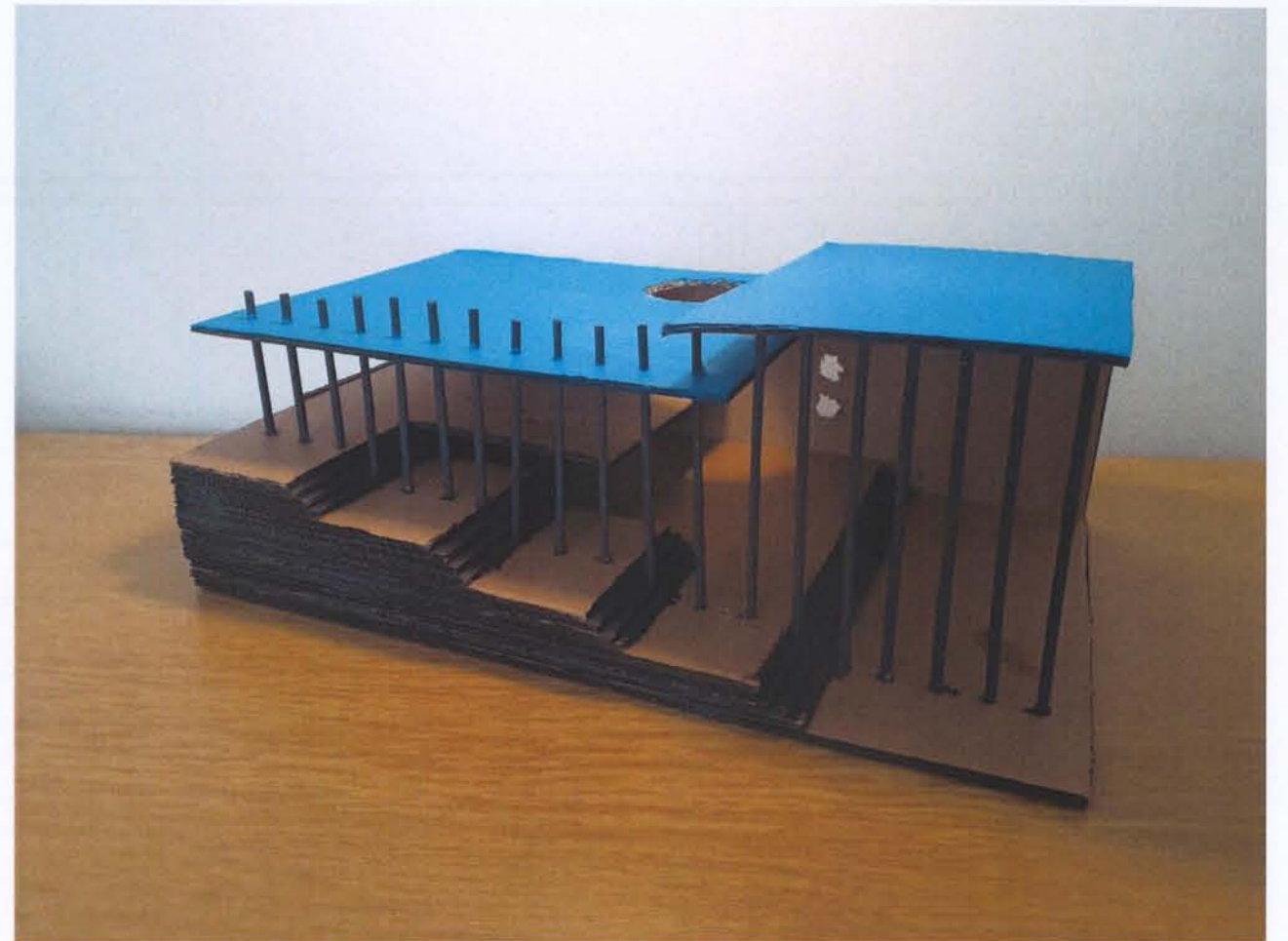
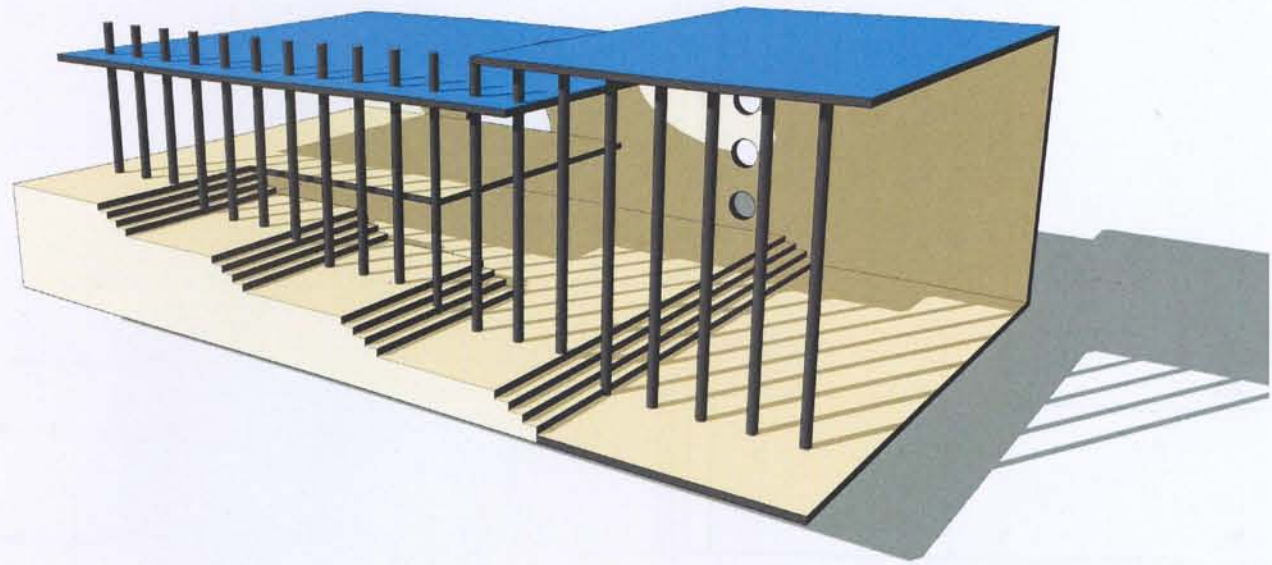

AVENIA

TLOČRT 1. KATA

TLOČRT PRIZEMLJA

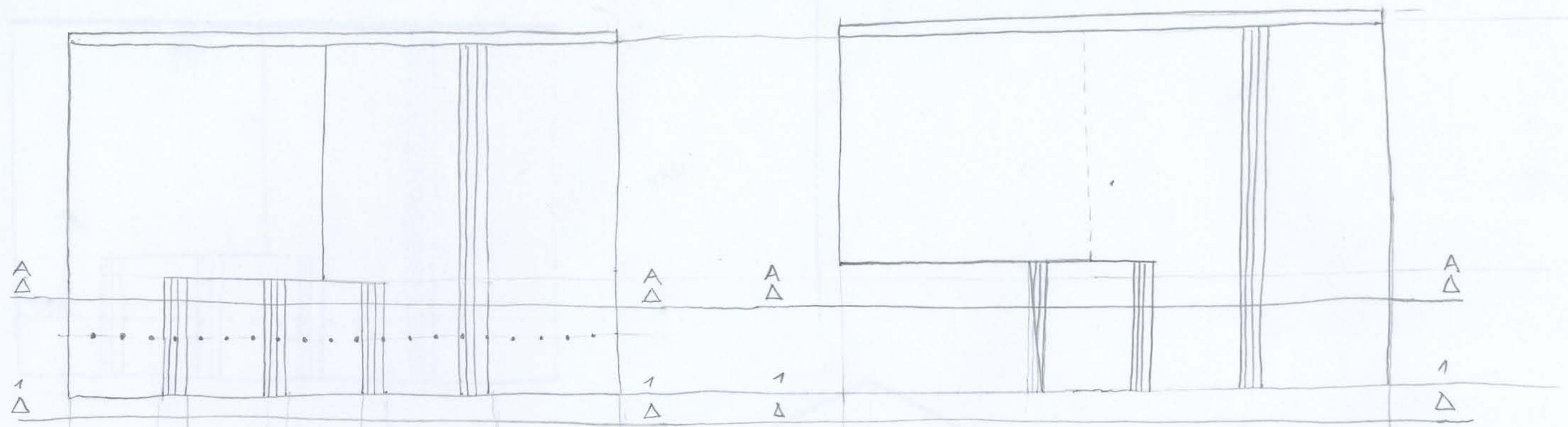

PRESJEK A-A

POGLED 1-1

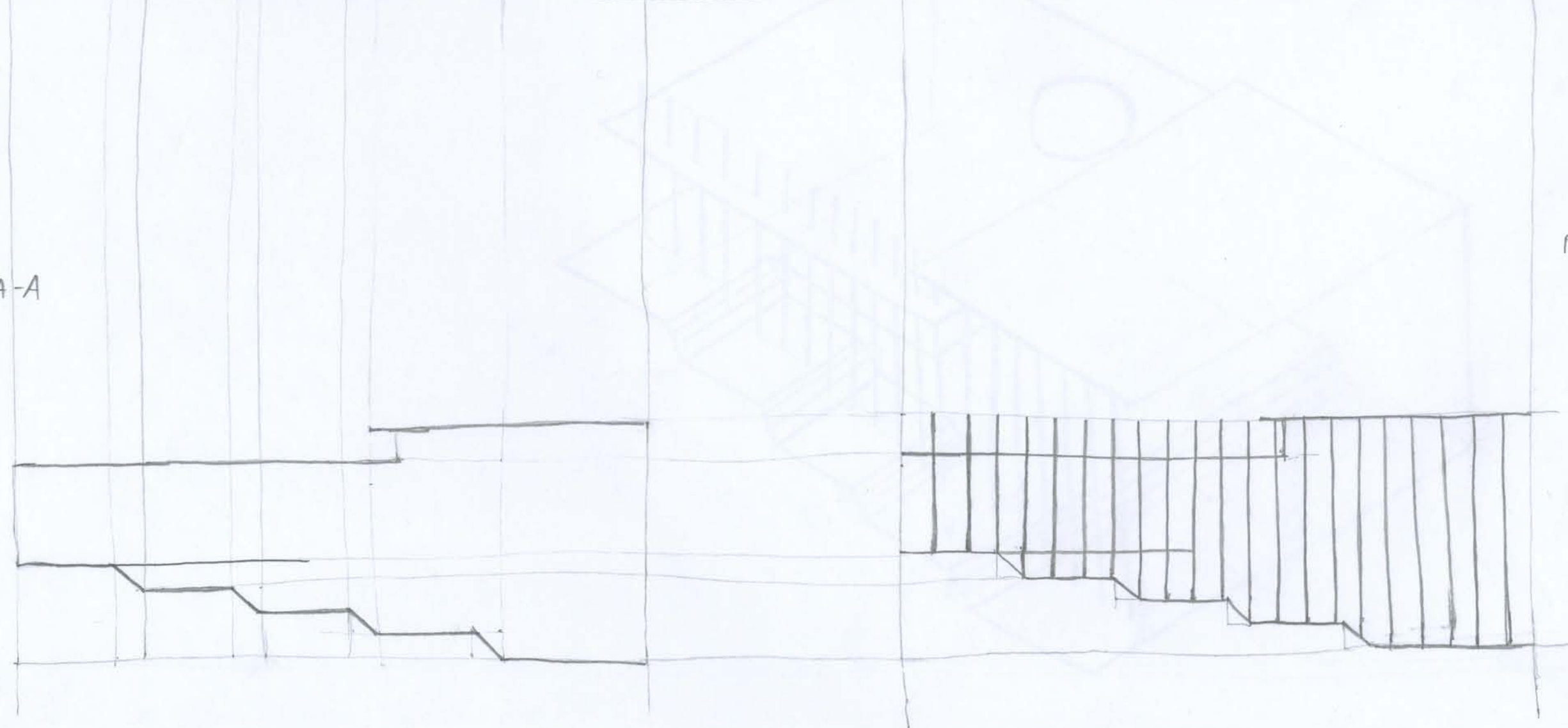

FILIP MURČIČ

AVENIJA



TRG

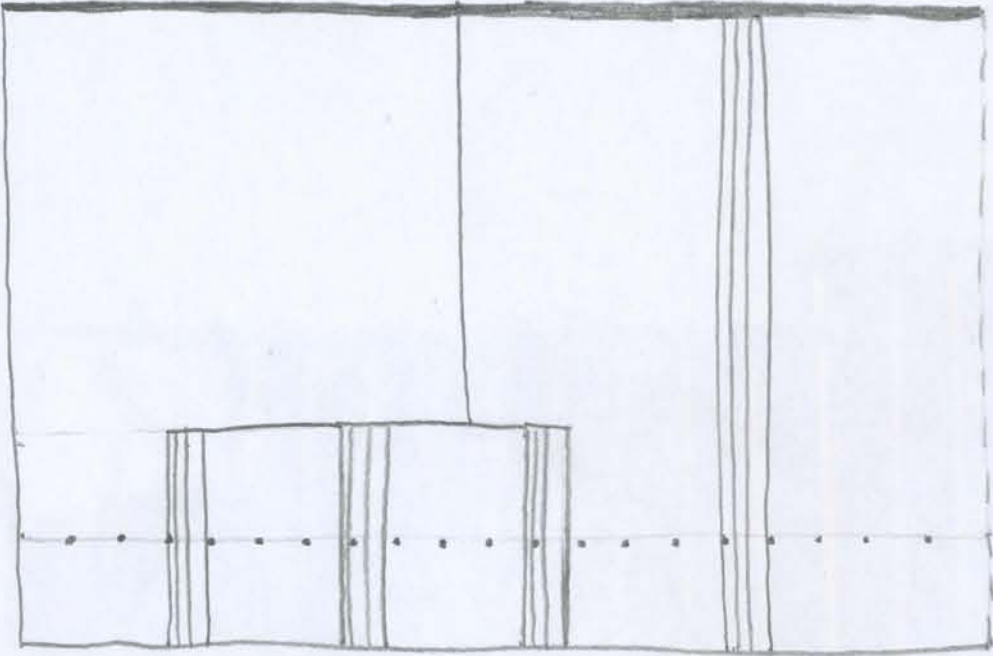

AKSONOMETRIJA

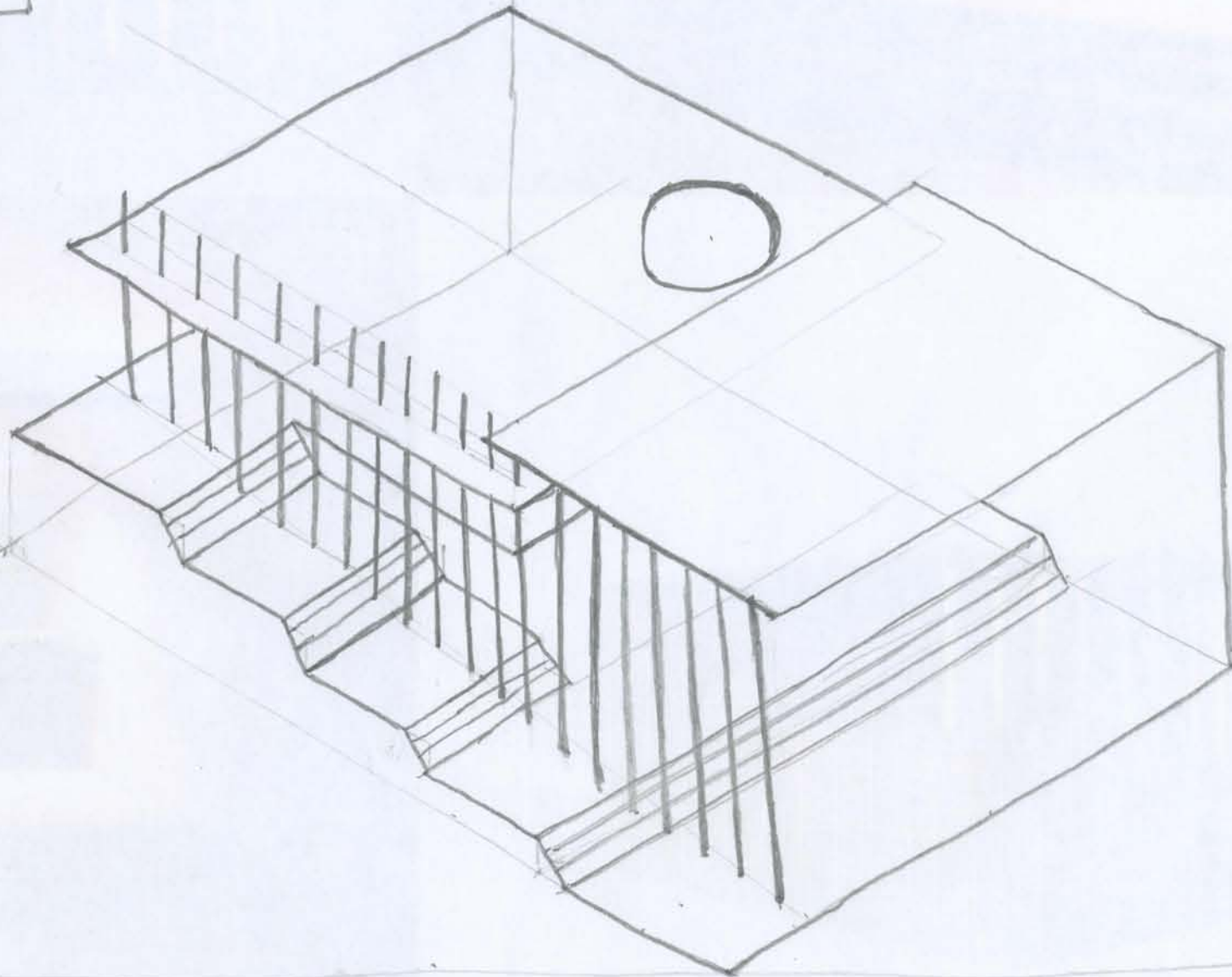

FILIP HOROŽIĆ

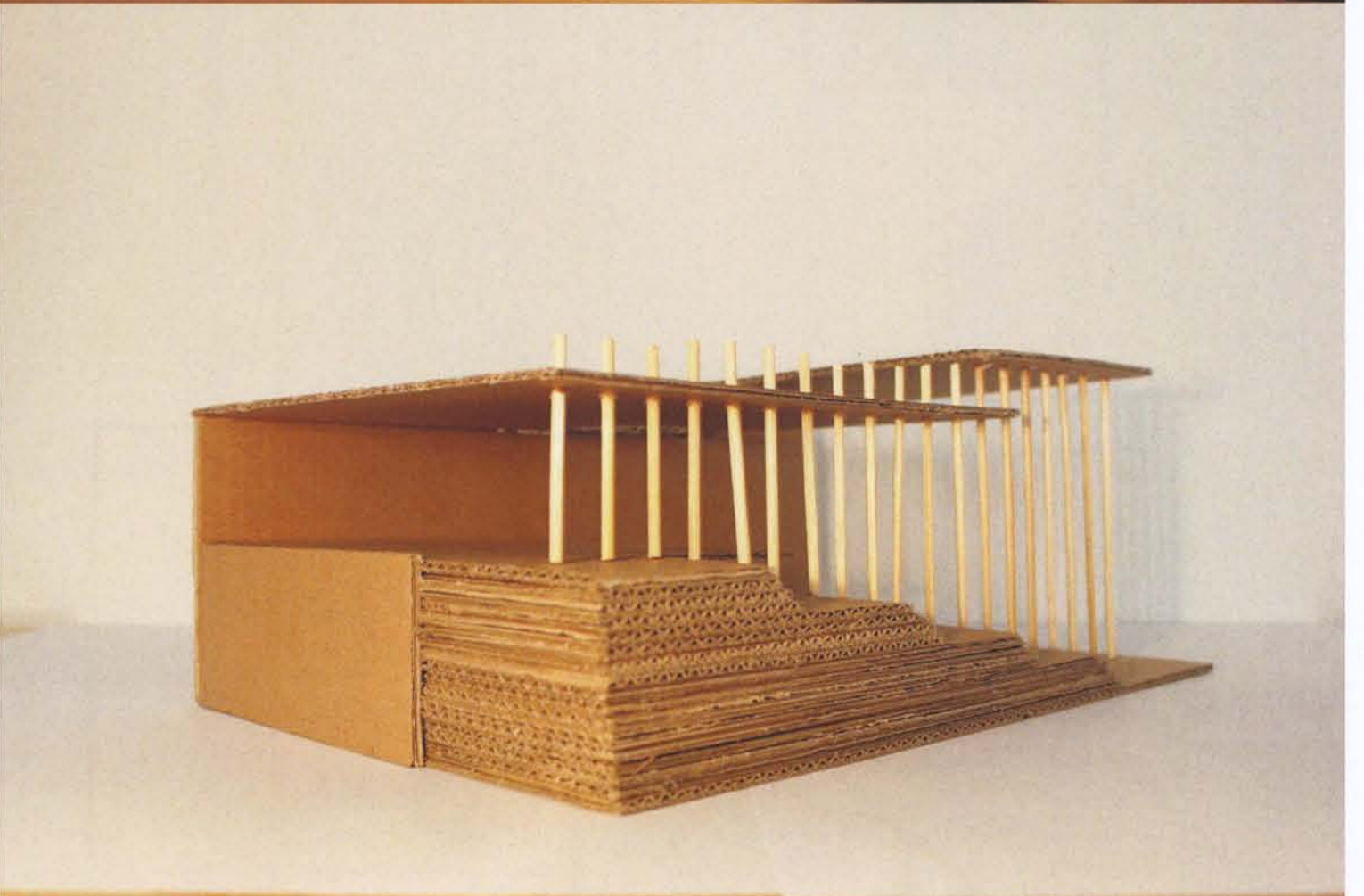
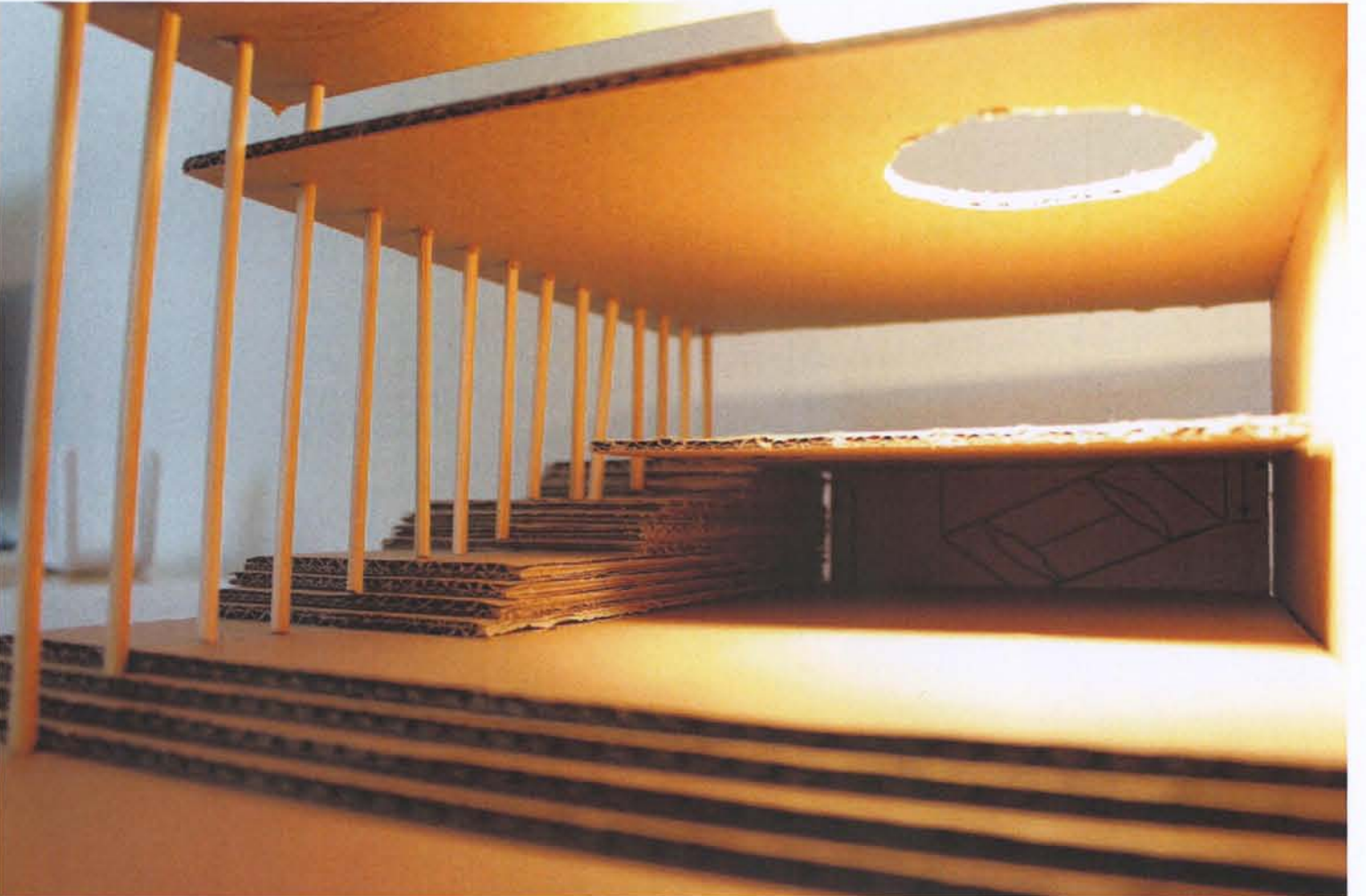
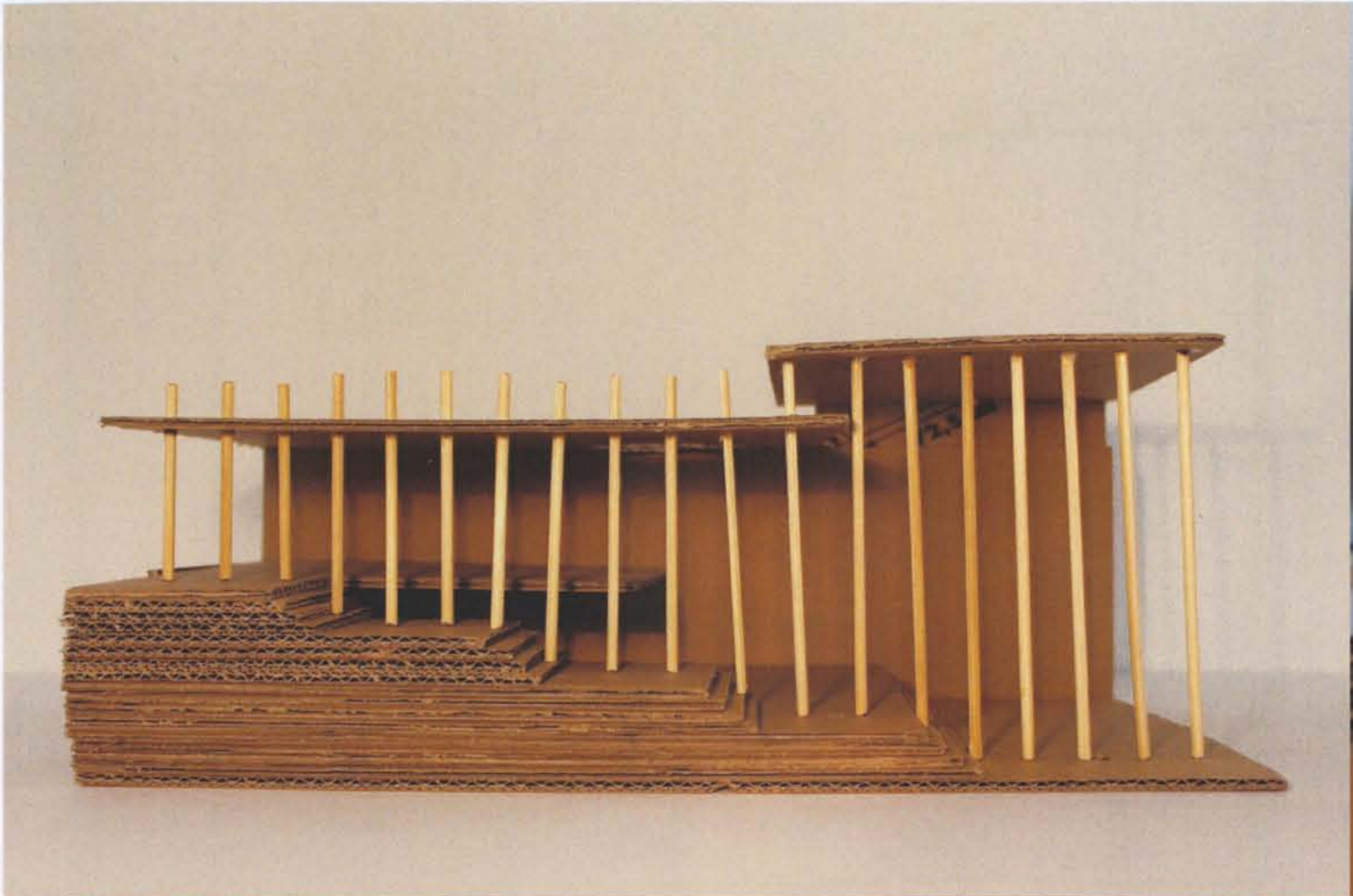

TLOČRT
PRIZEMJA

AVENIA

TLOČRT 1. KATA

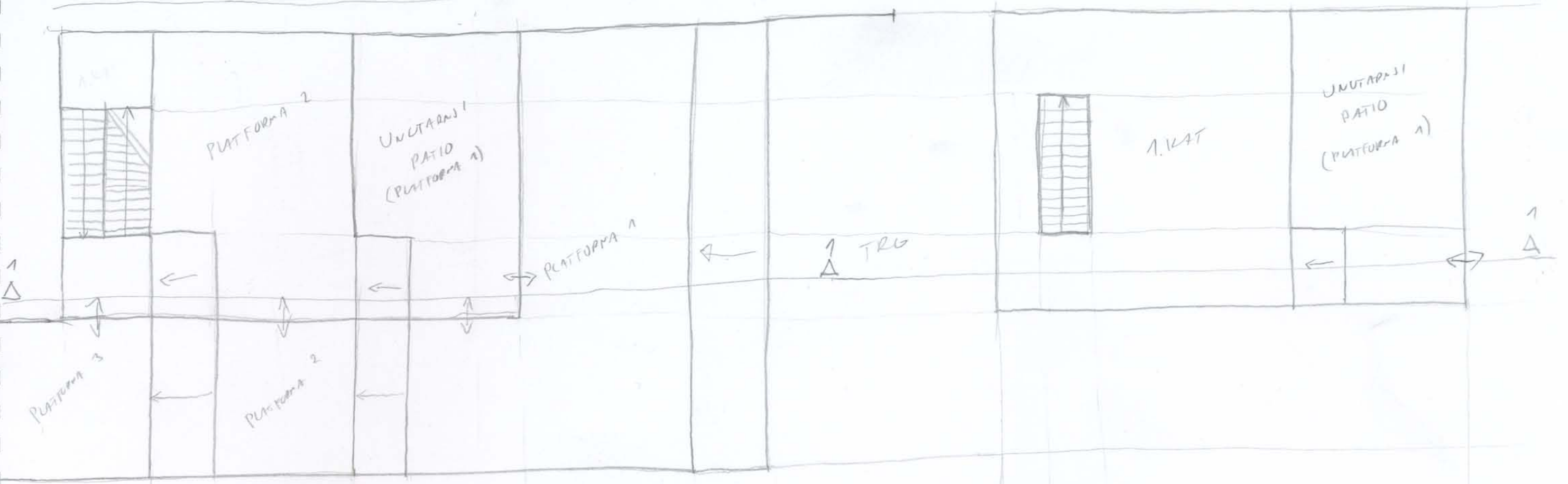

PRESEK
1-1

TLOČRT
PODOLNA

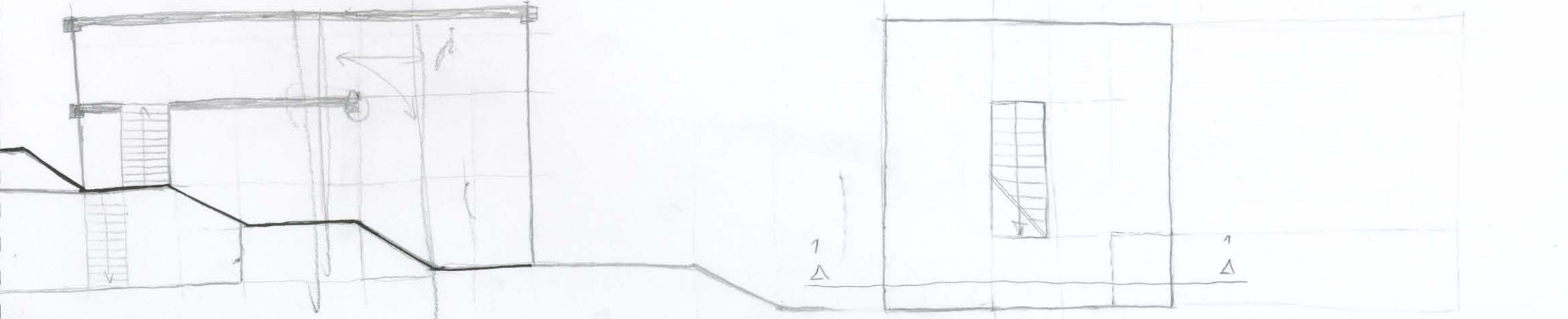

FILIP MOROŽIČ

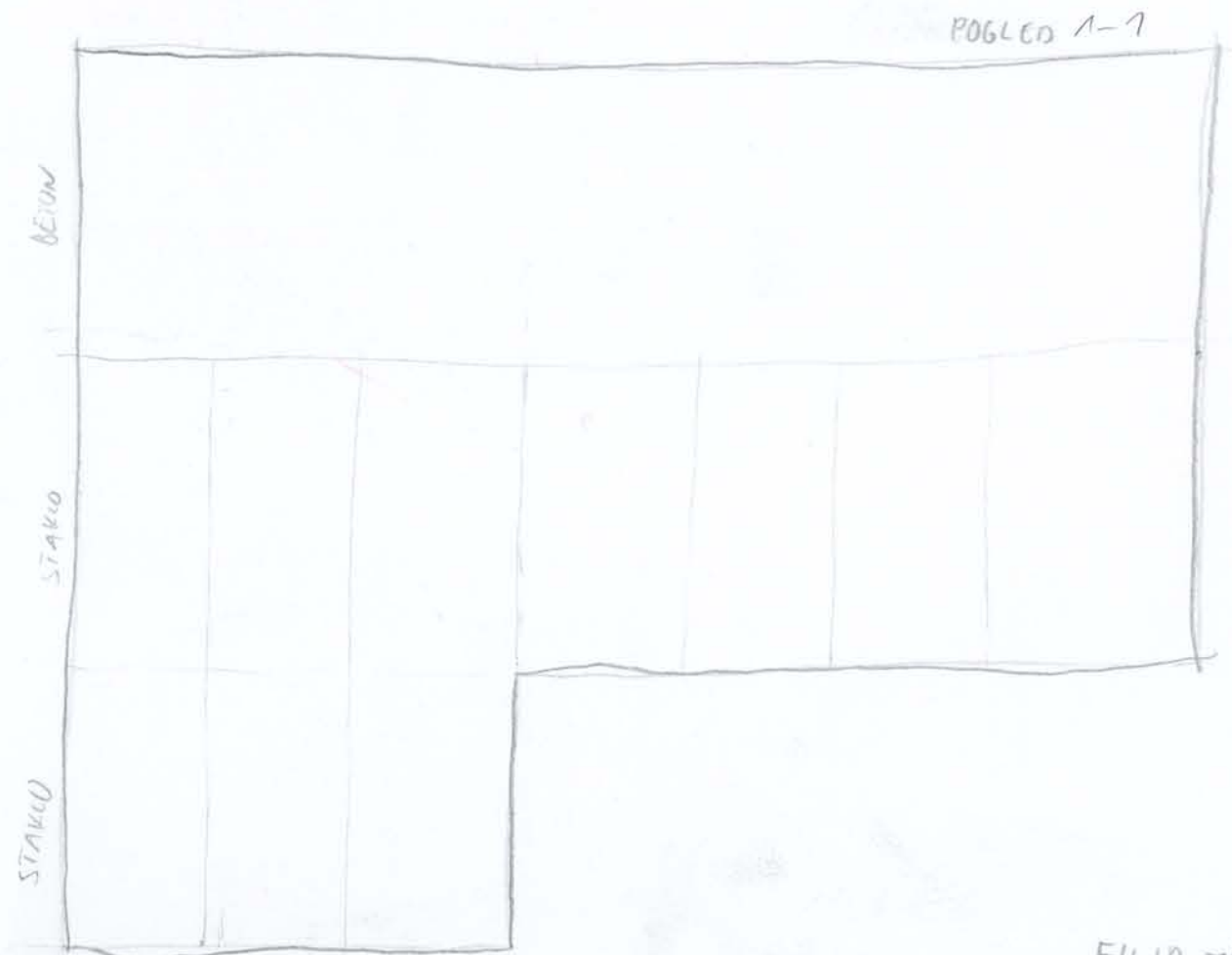
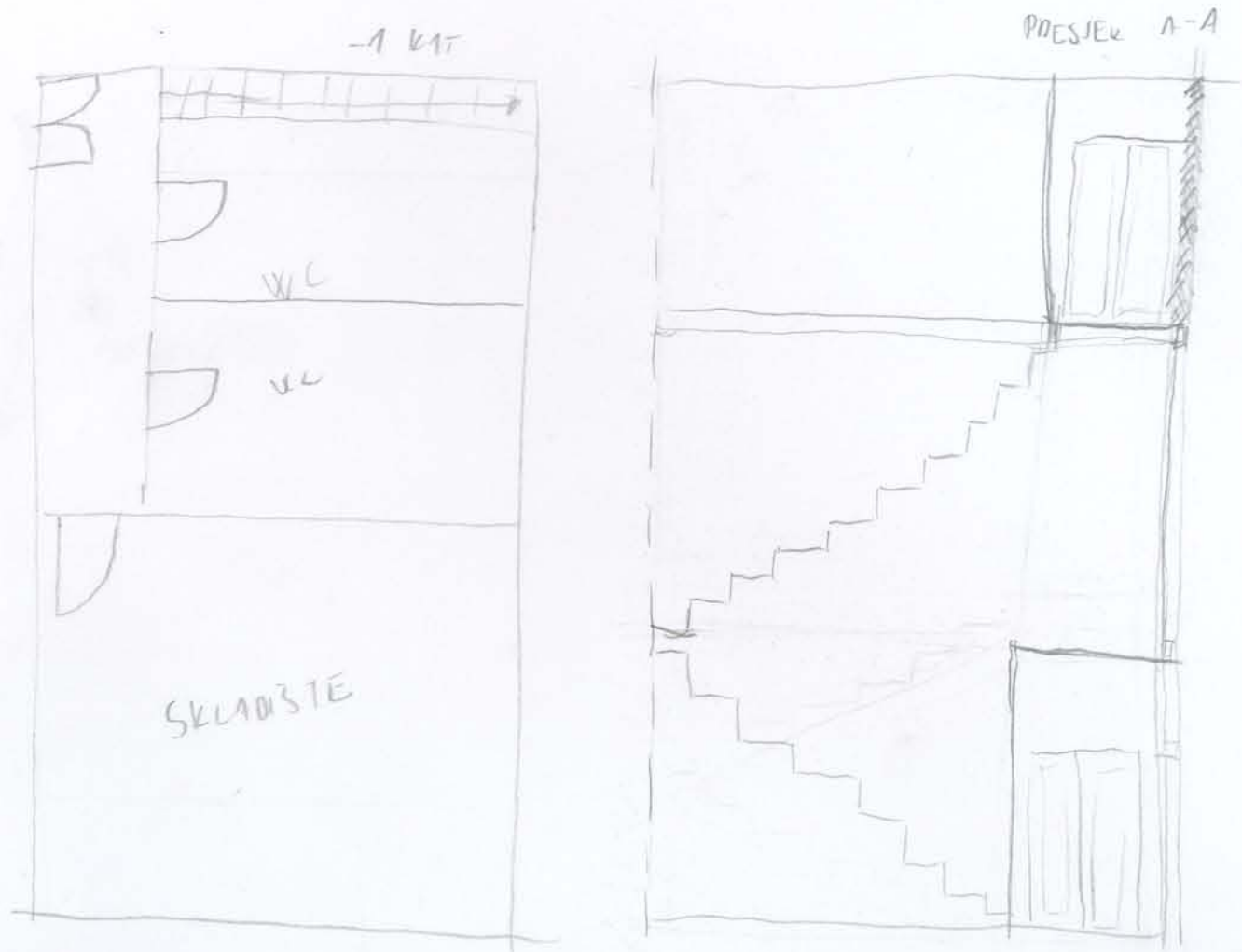
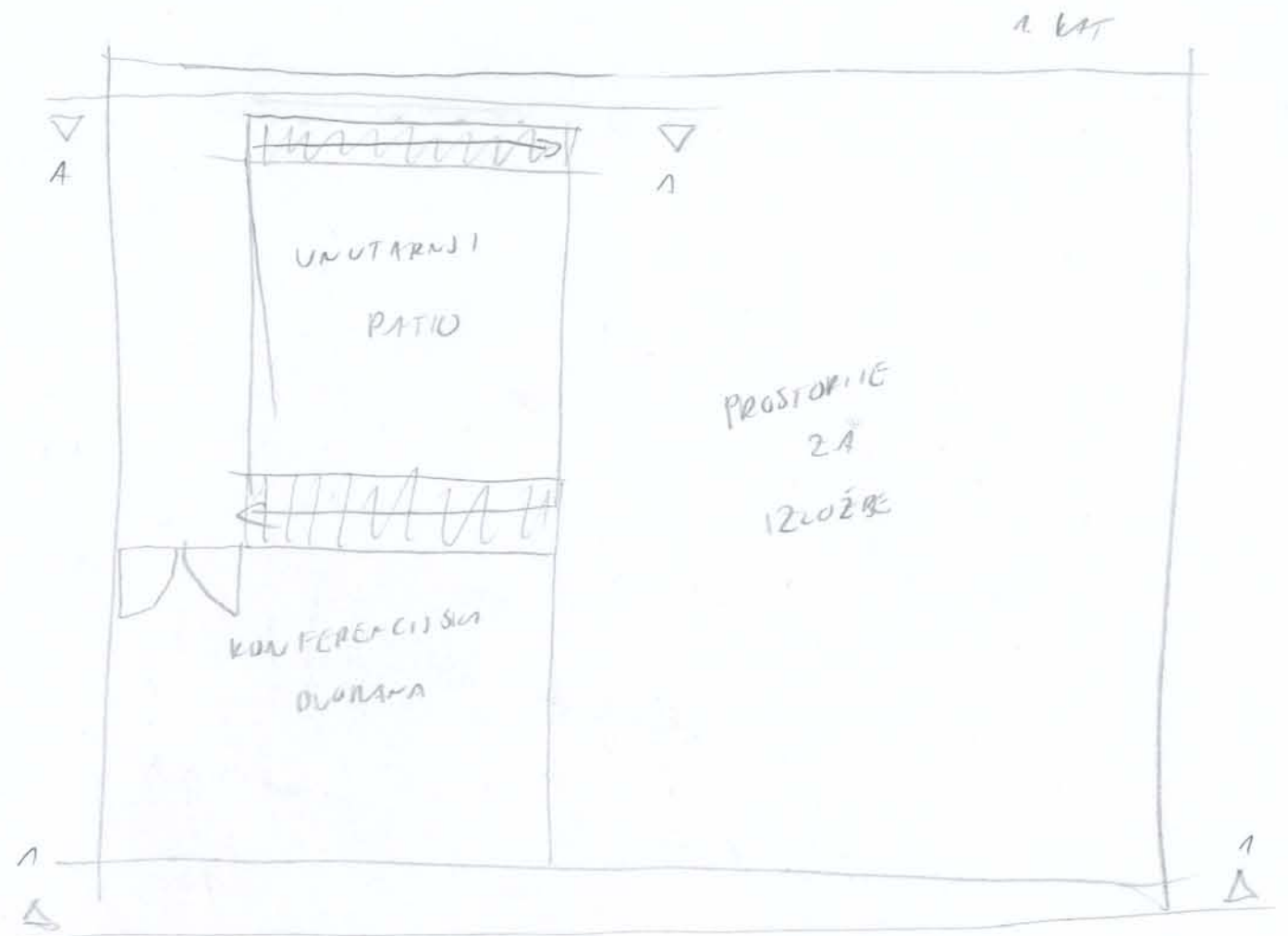
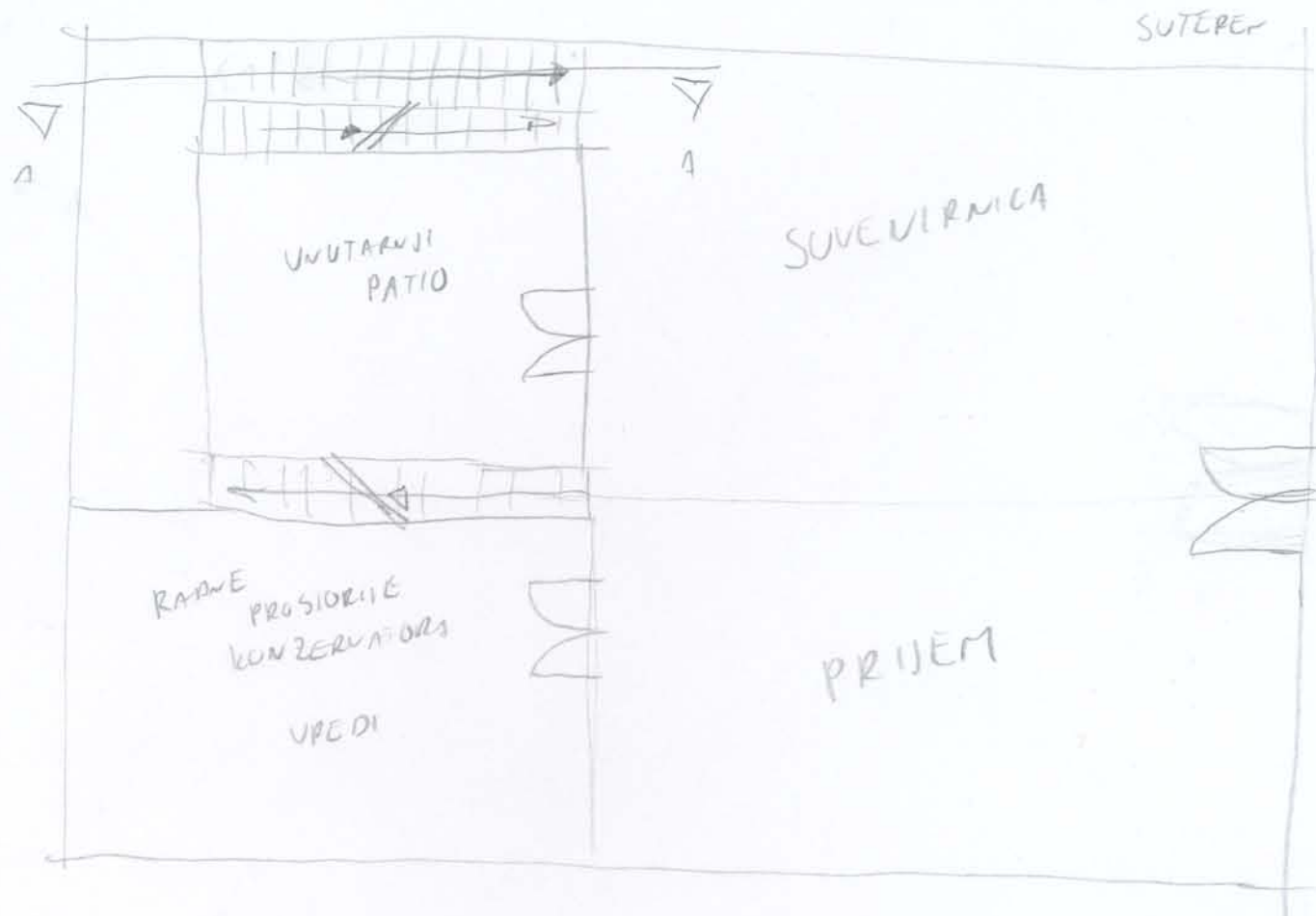

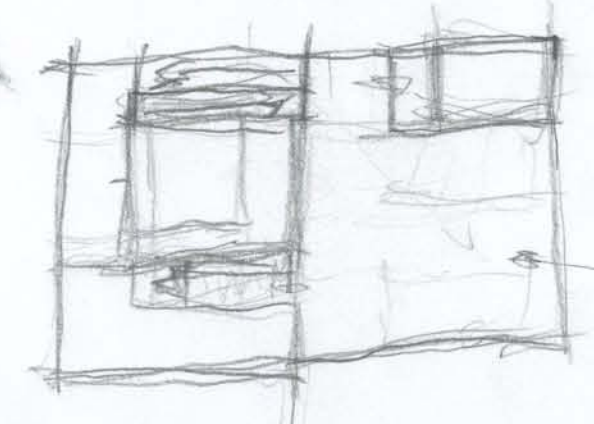
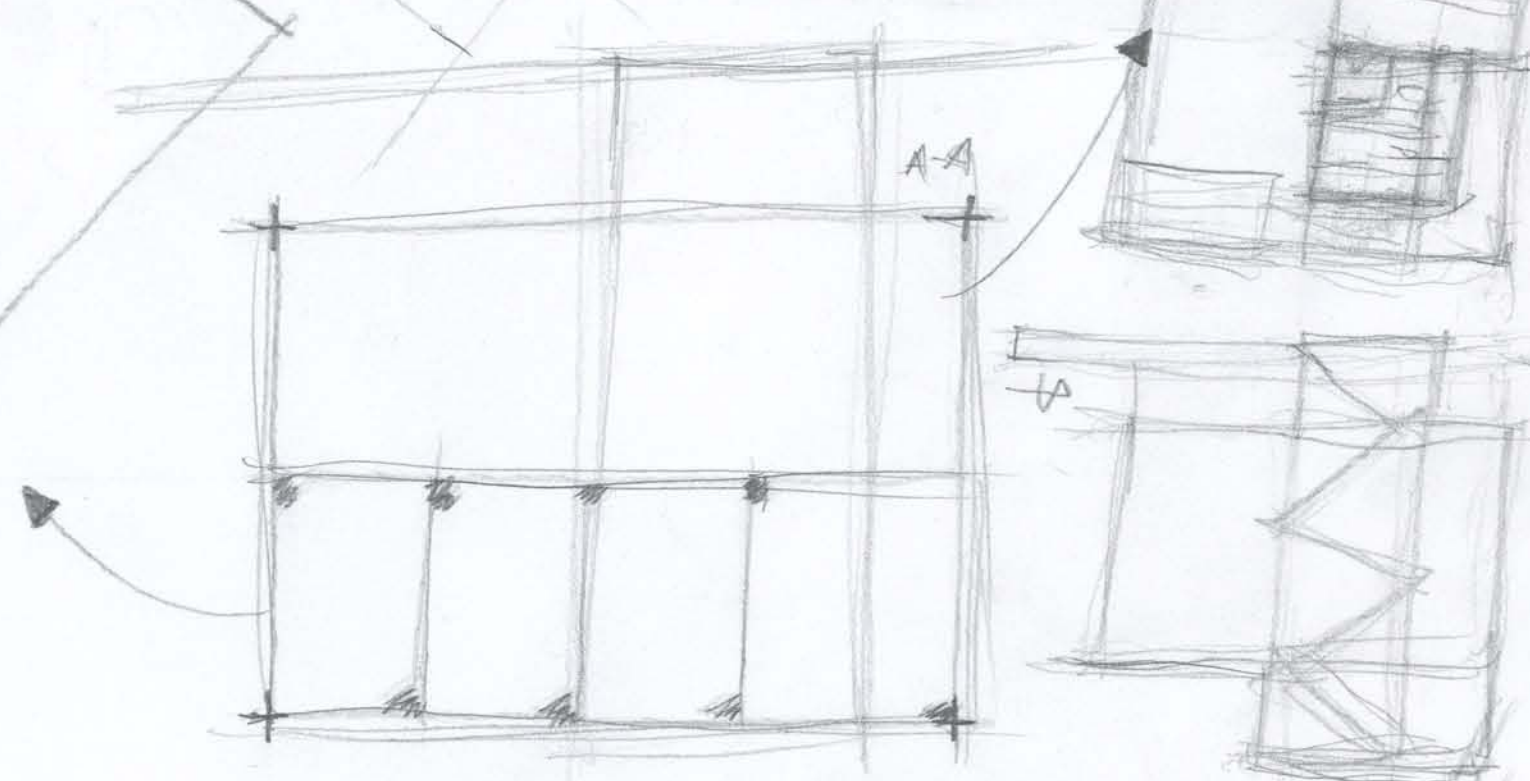
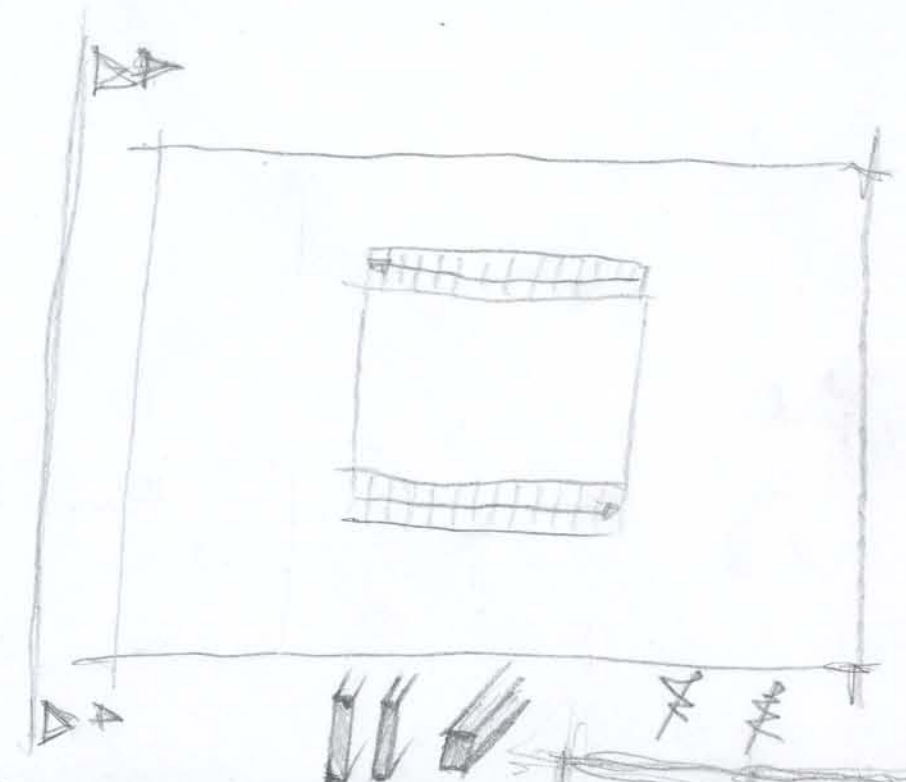
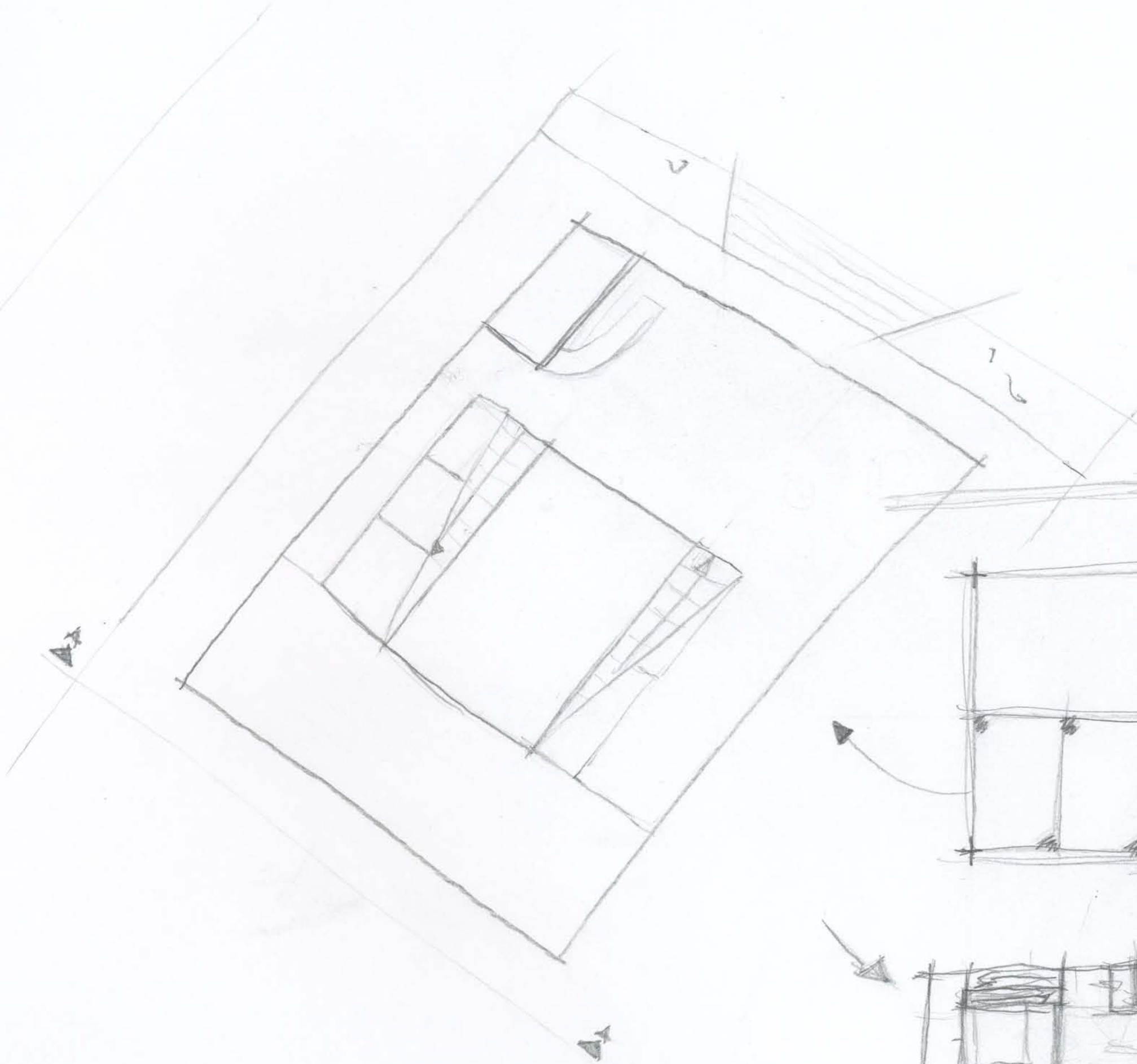

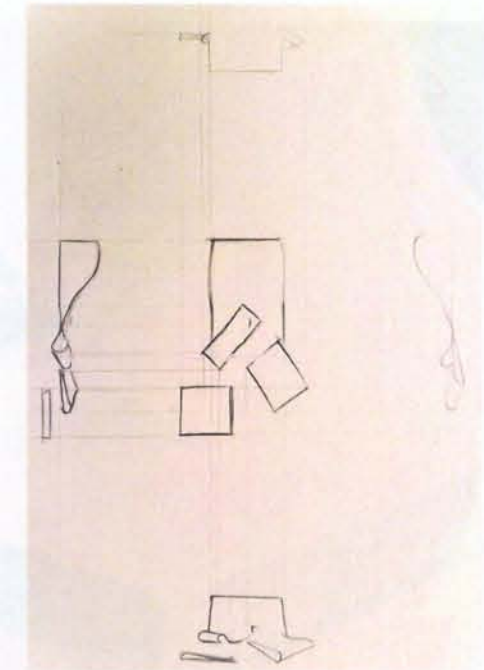
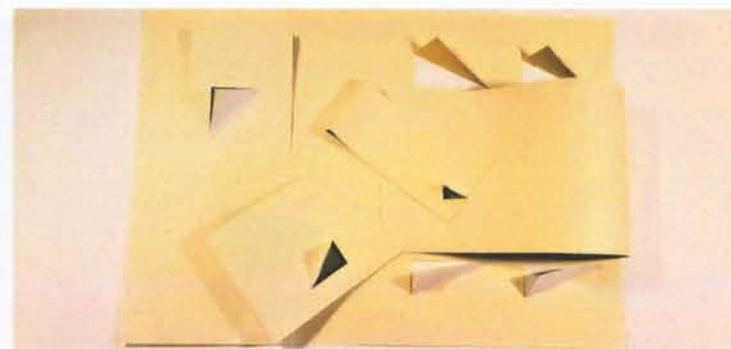
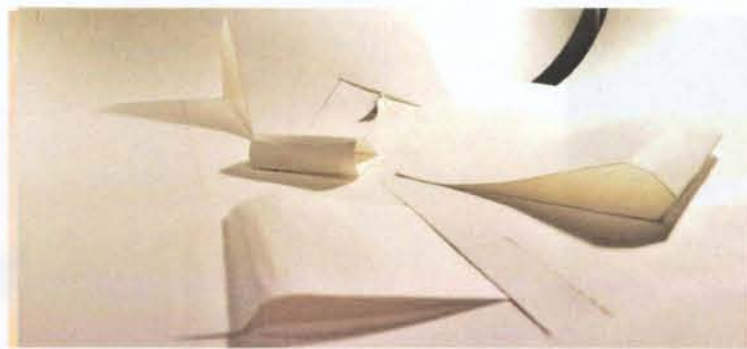

LUCIJA BUŽANČIĆ

OSNOVE ARHITEKTONSKOG PROJEKTIRANJA

Mentori: izv.prof.art. Stanko Stergaršek, di.a., asistent Aneta Mudronja Pletenac, di.a.

STUDIJ KRAJOBRAZNA ARHITEKTURA - 1. semestar Bs - ak.god. 2020/21

2 MAKETA

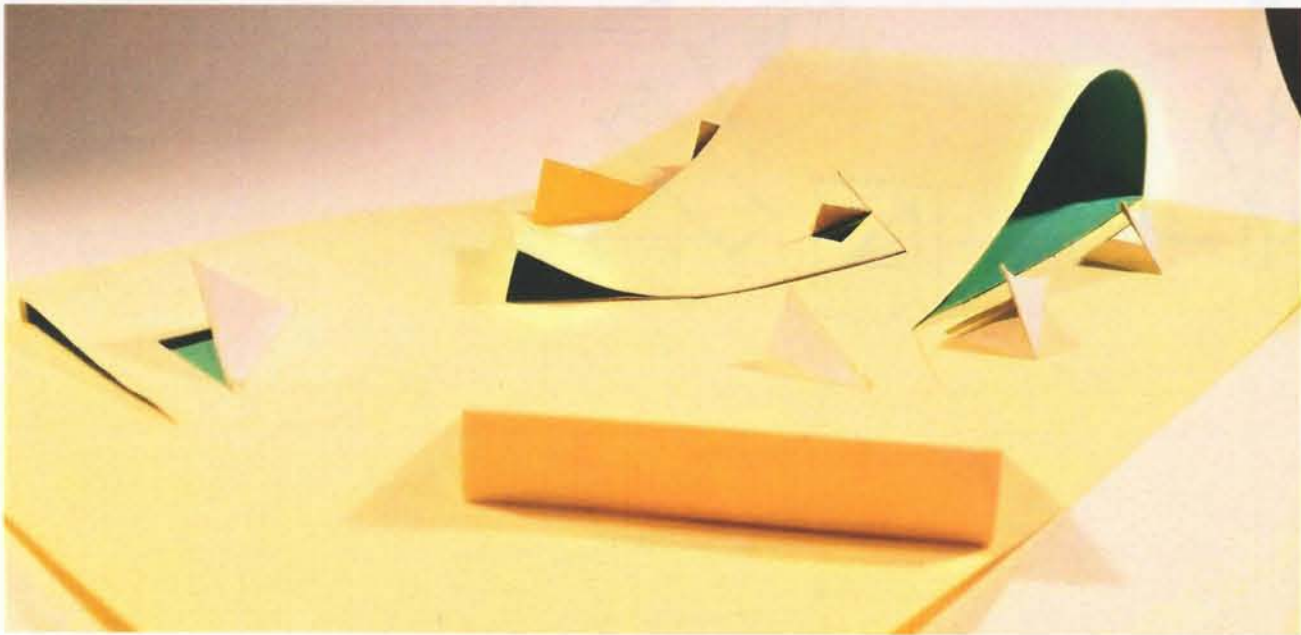
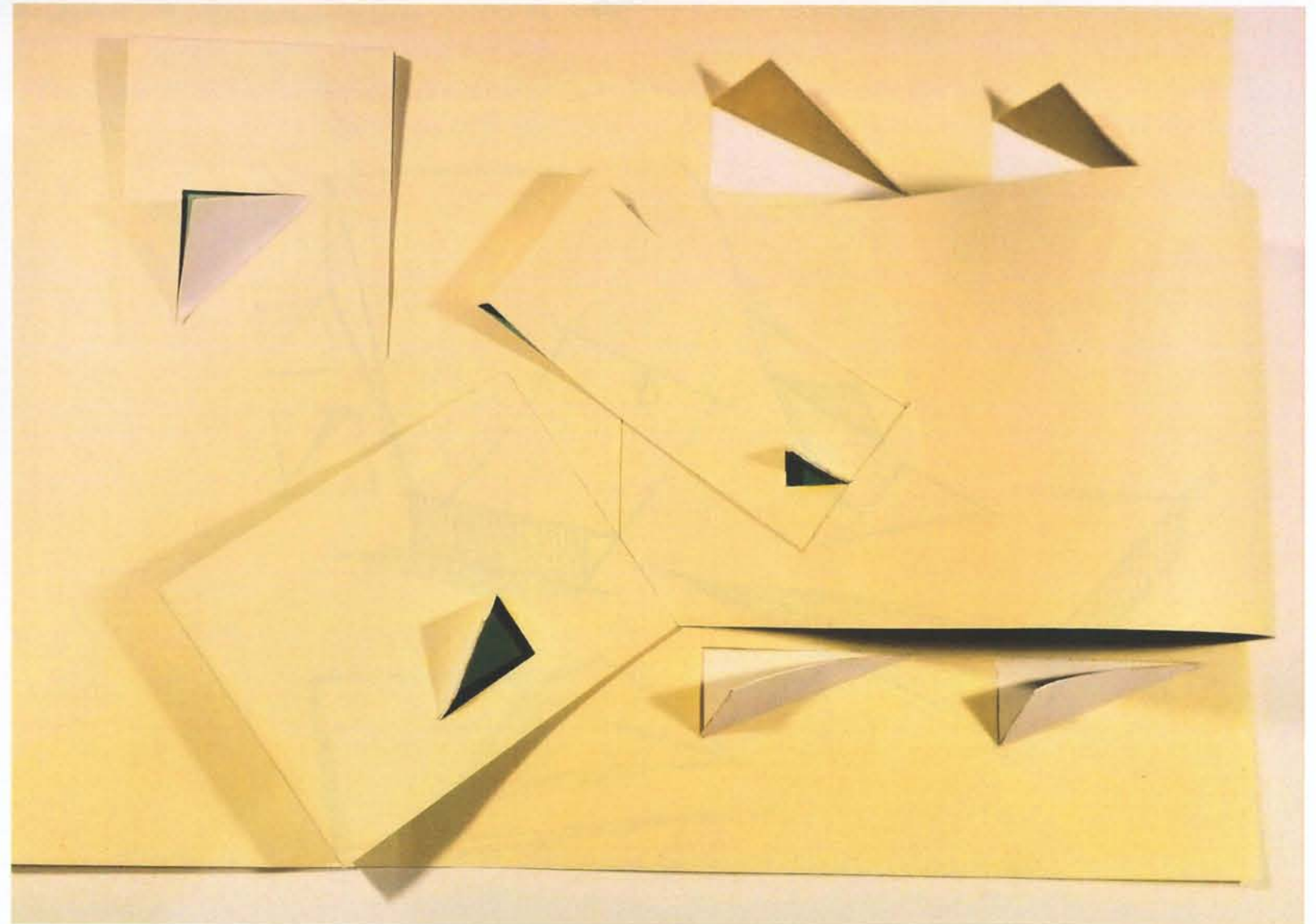
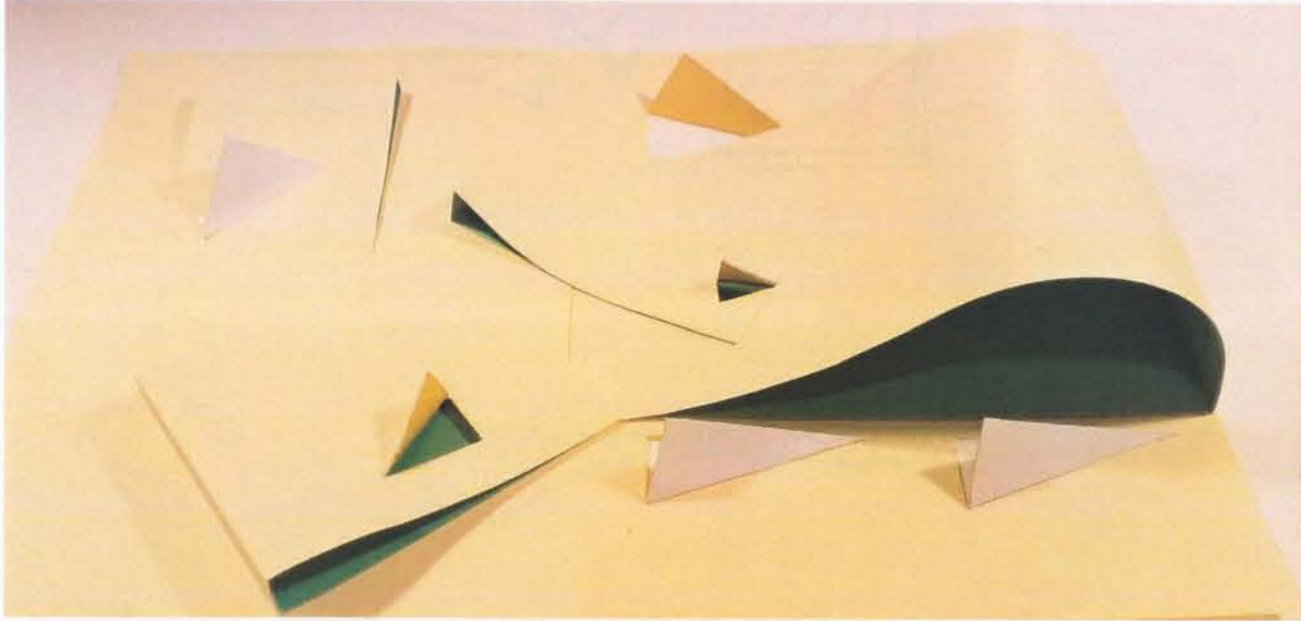
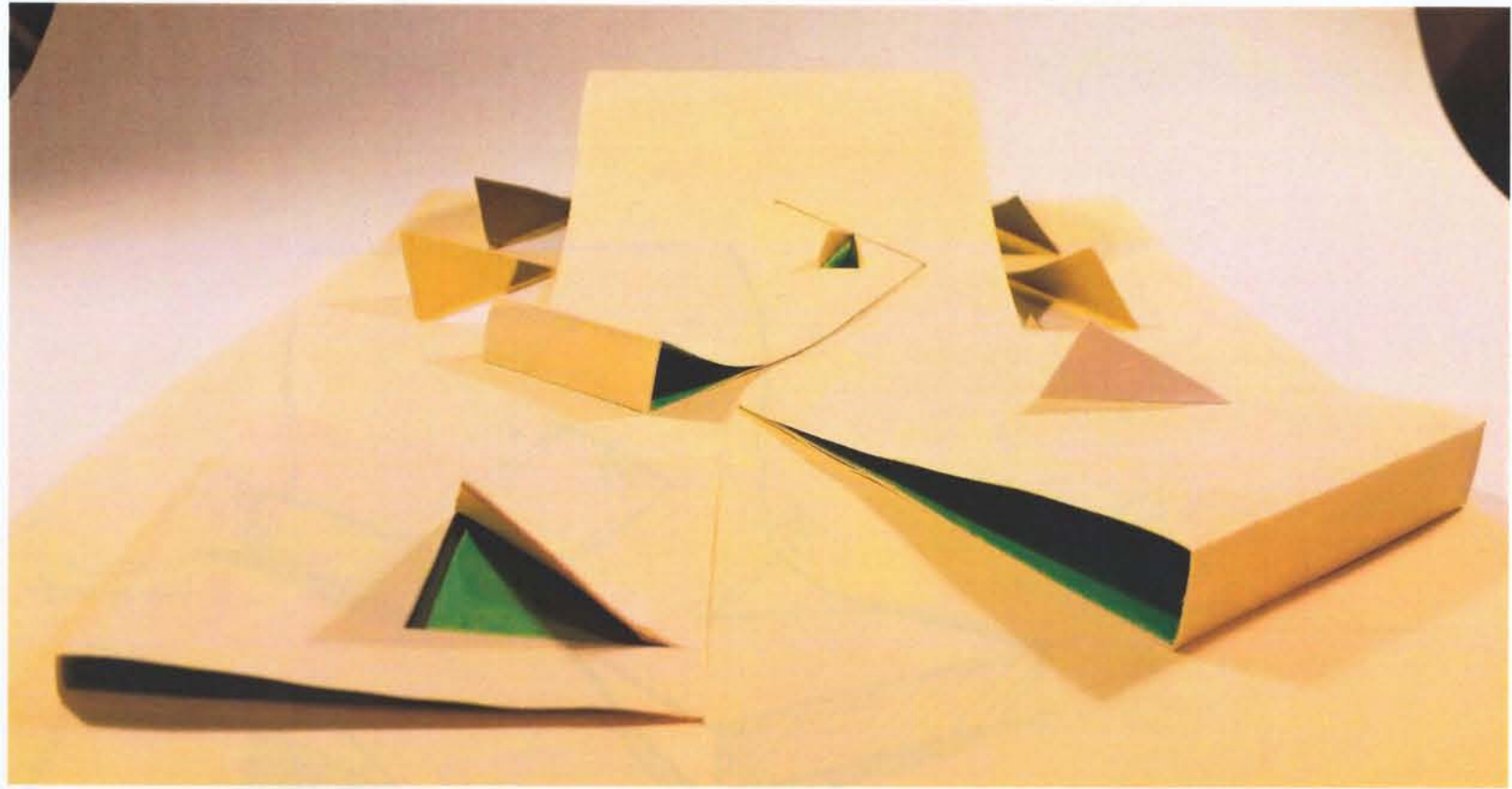
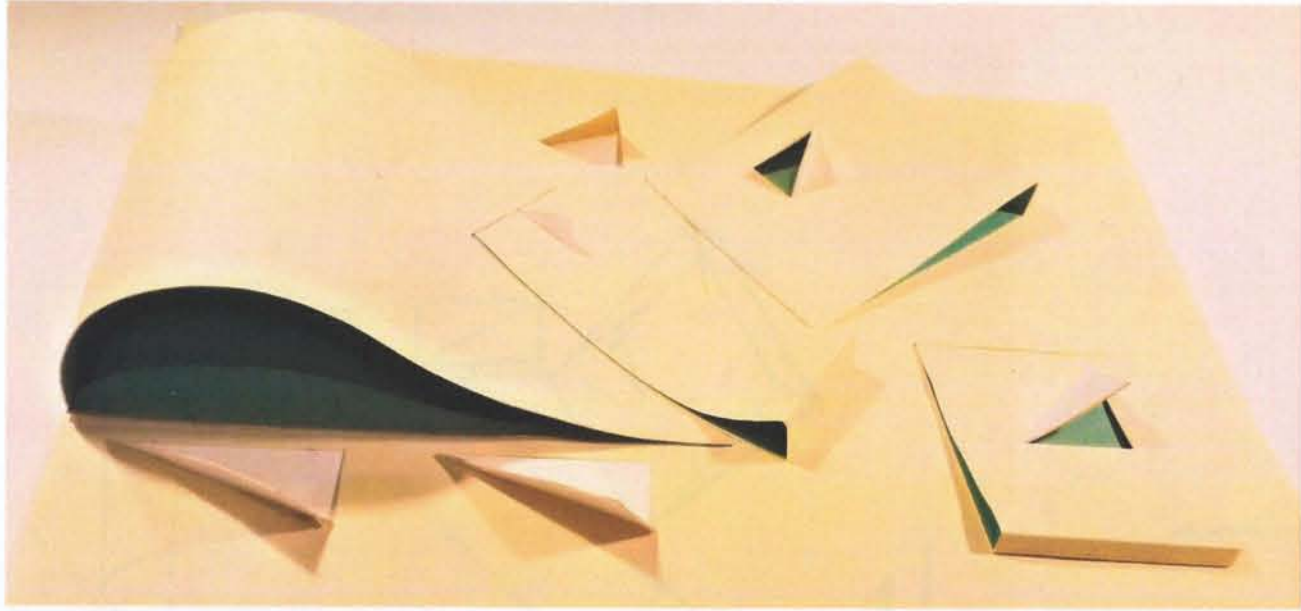

SKICE2 MAKETE

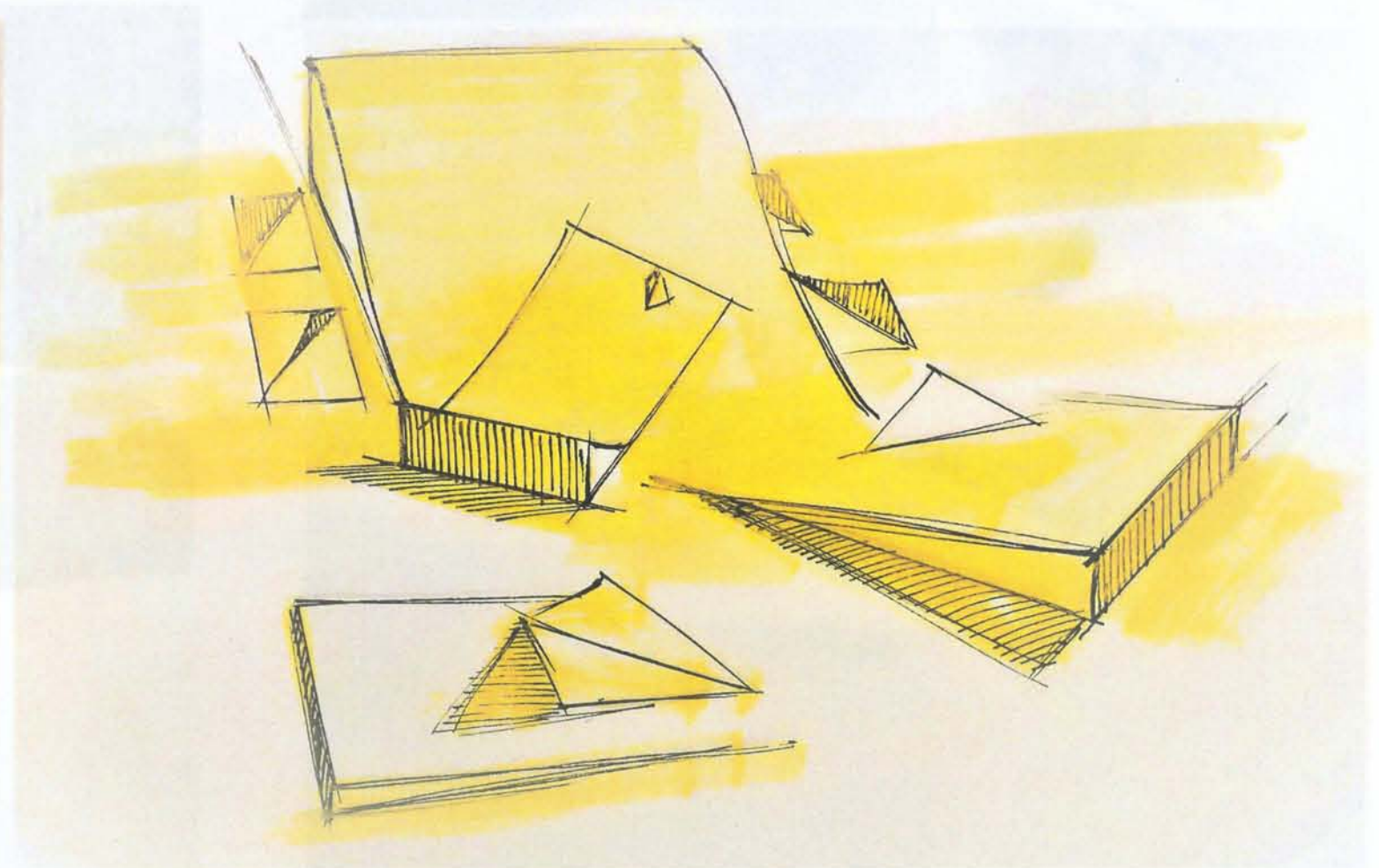
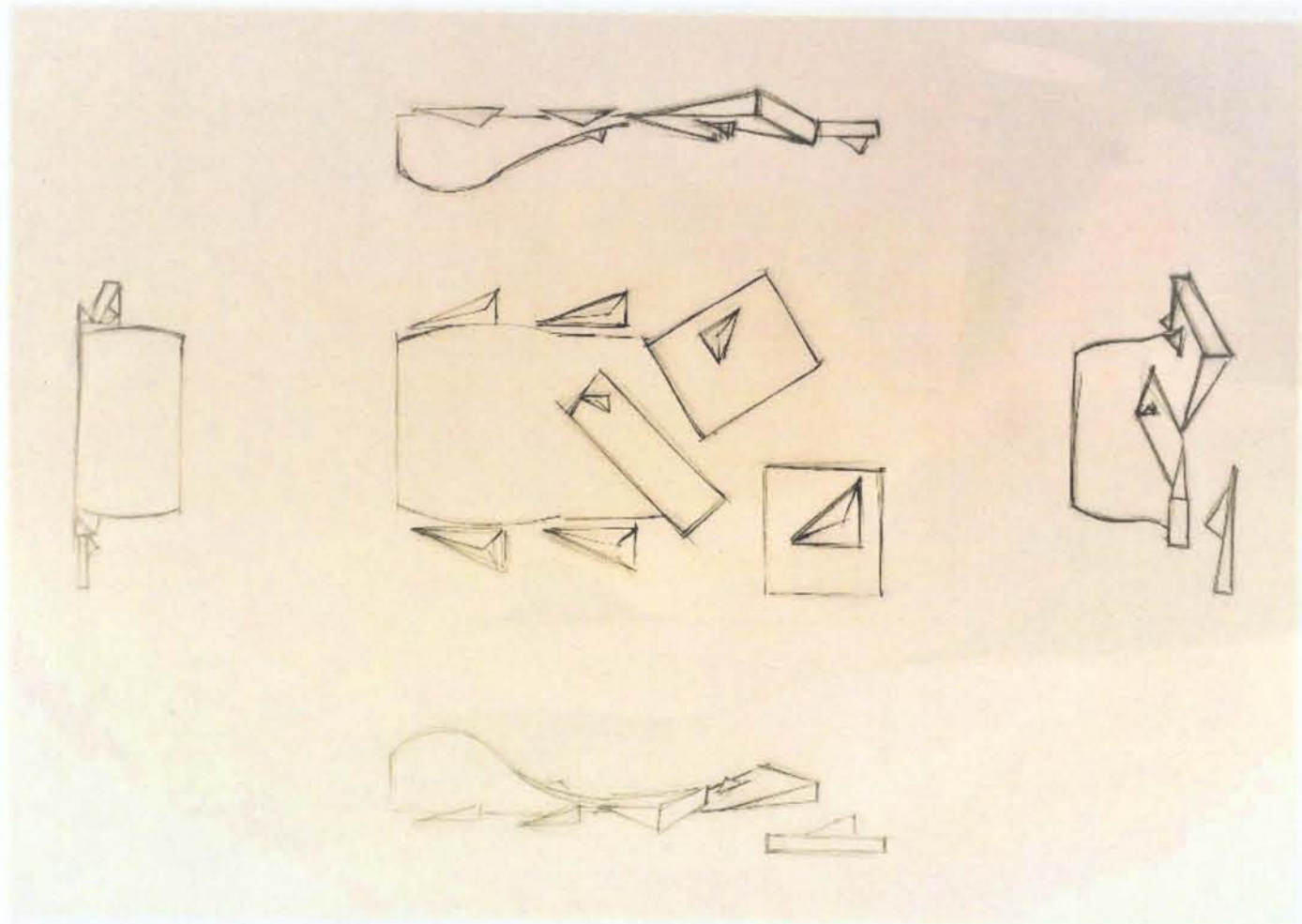
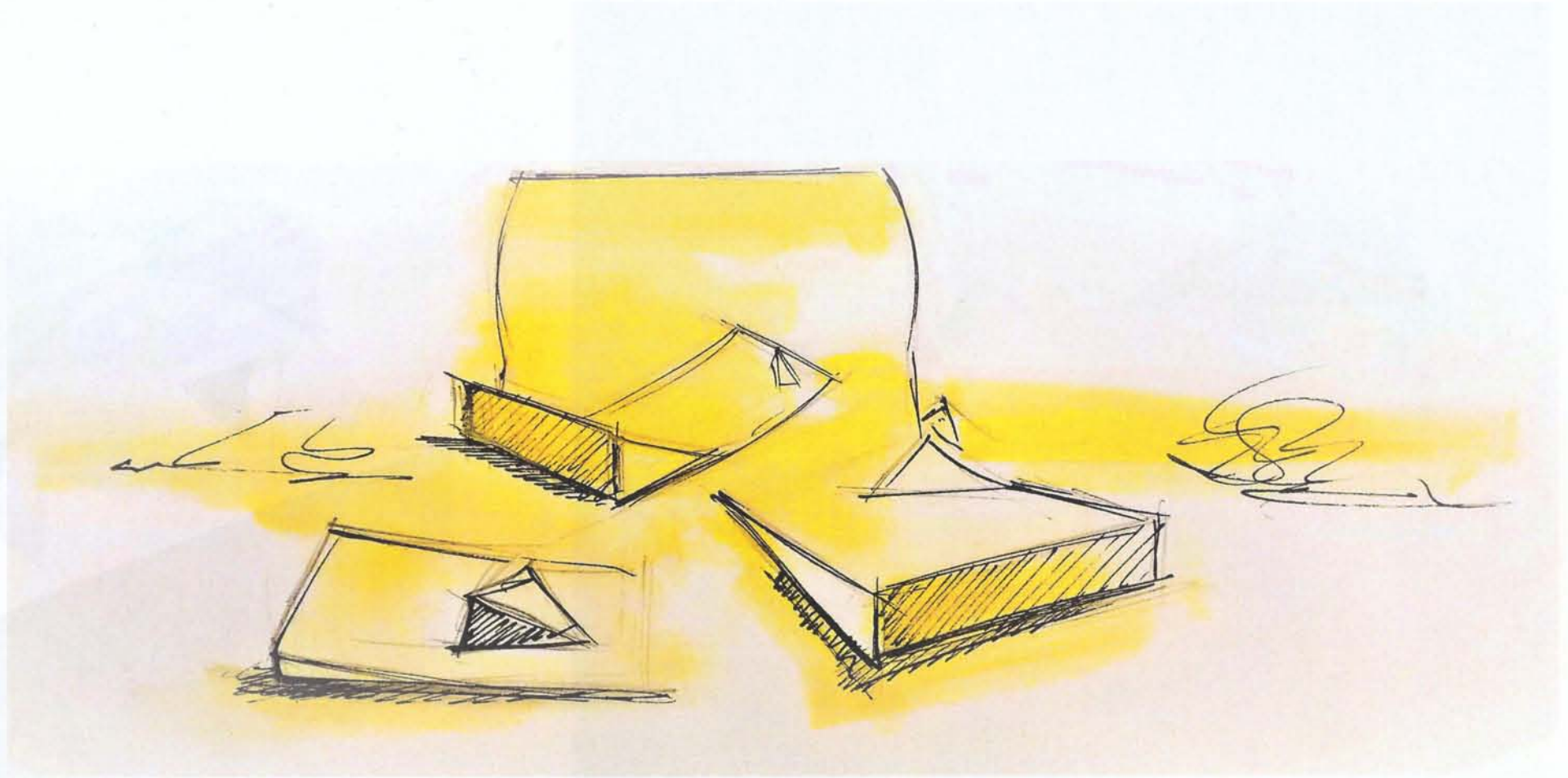
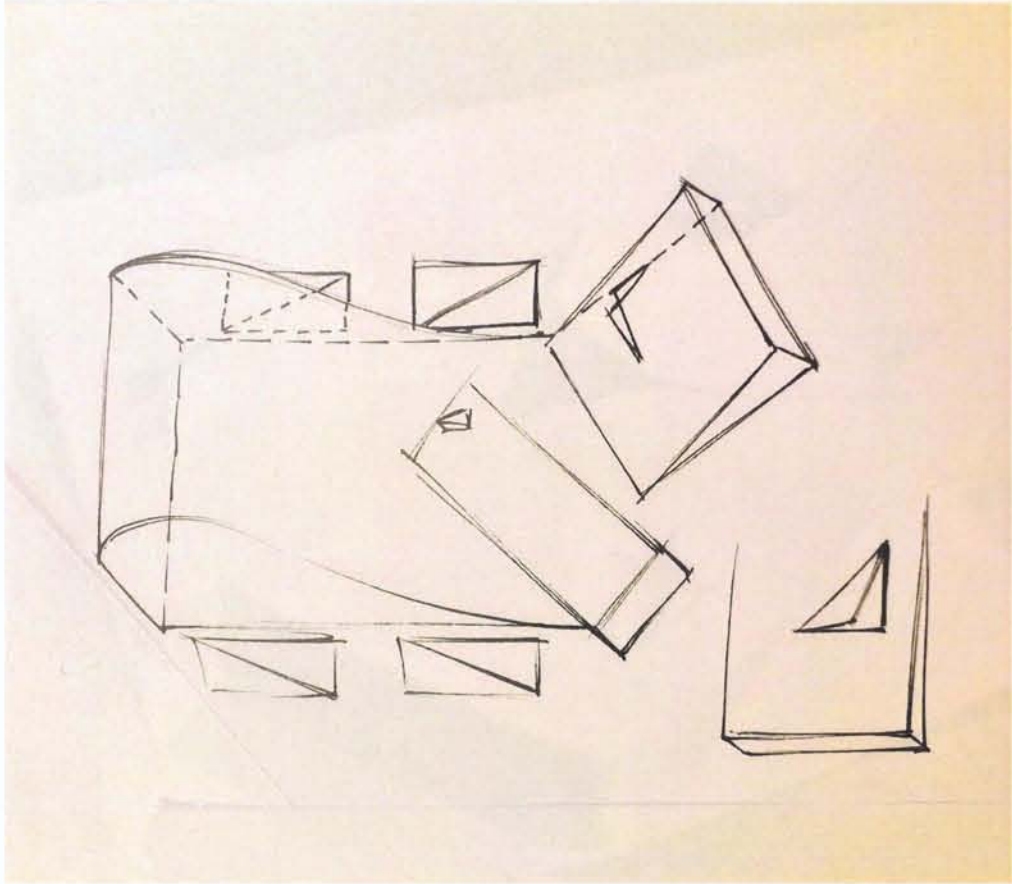

1. MAKETA KETE

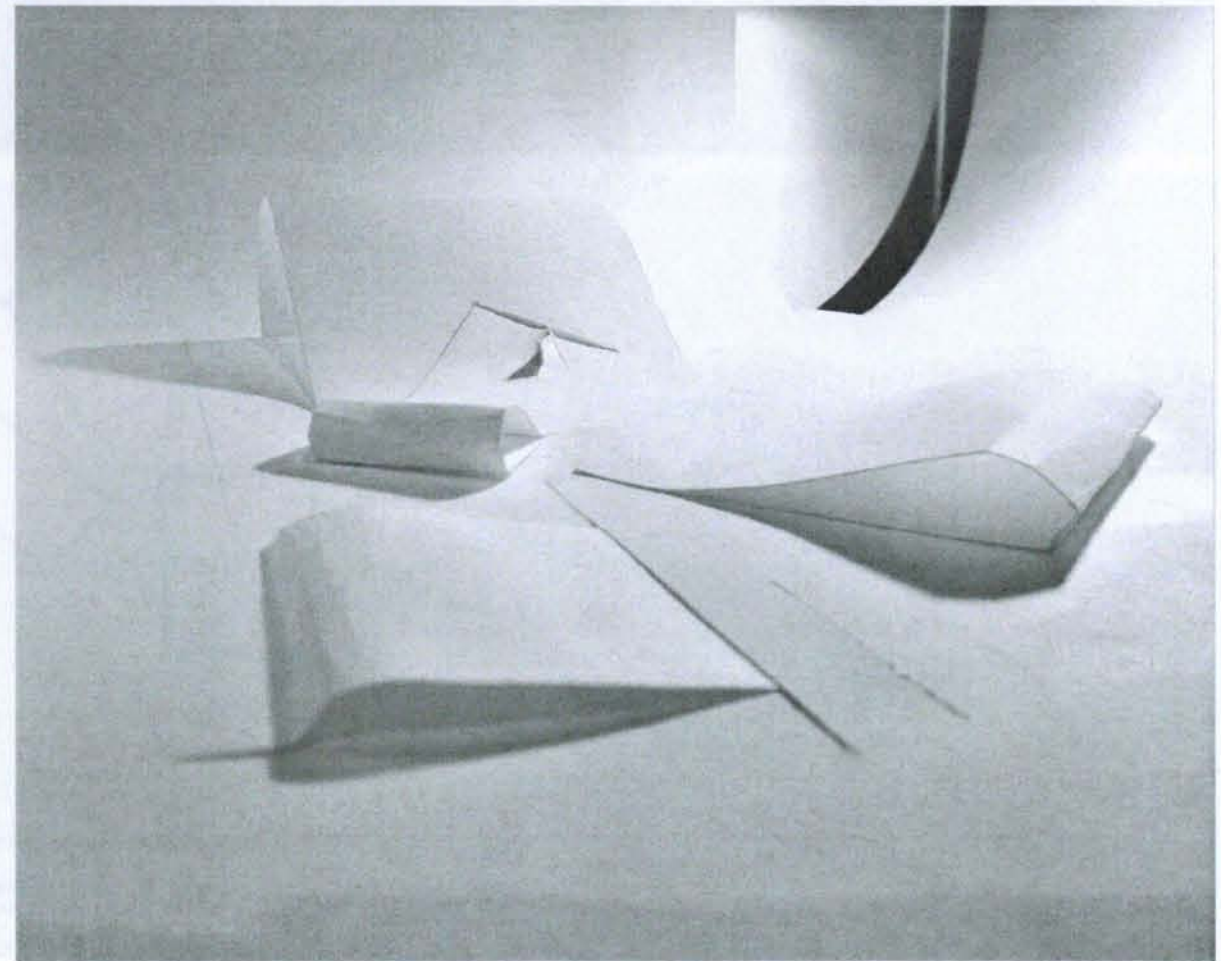
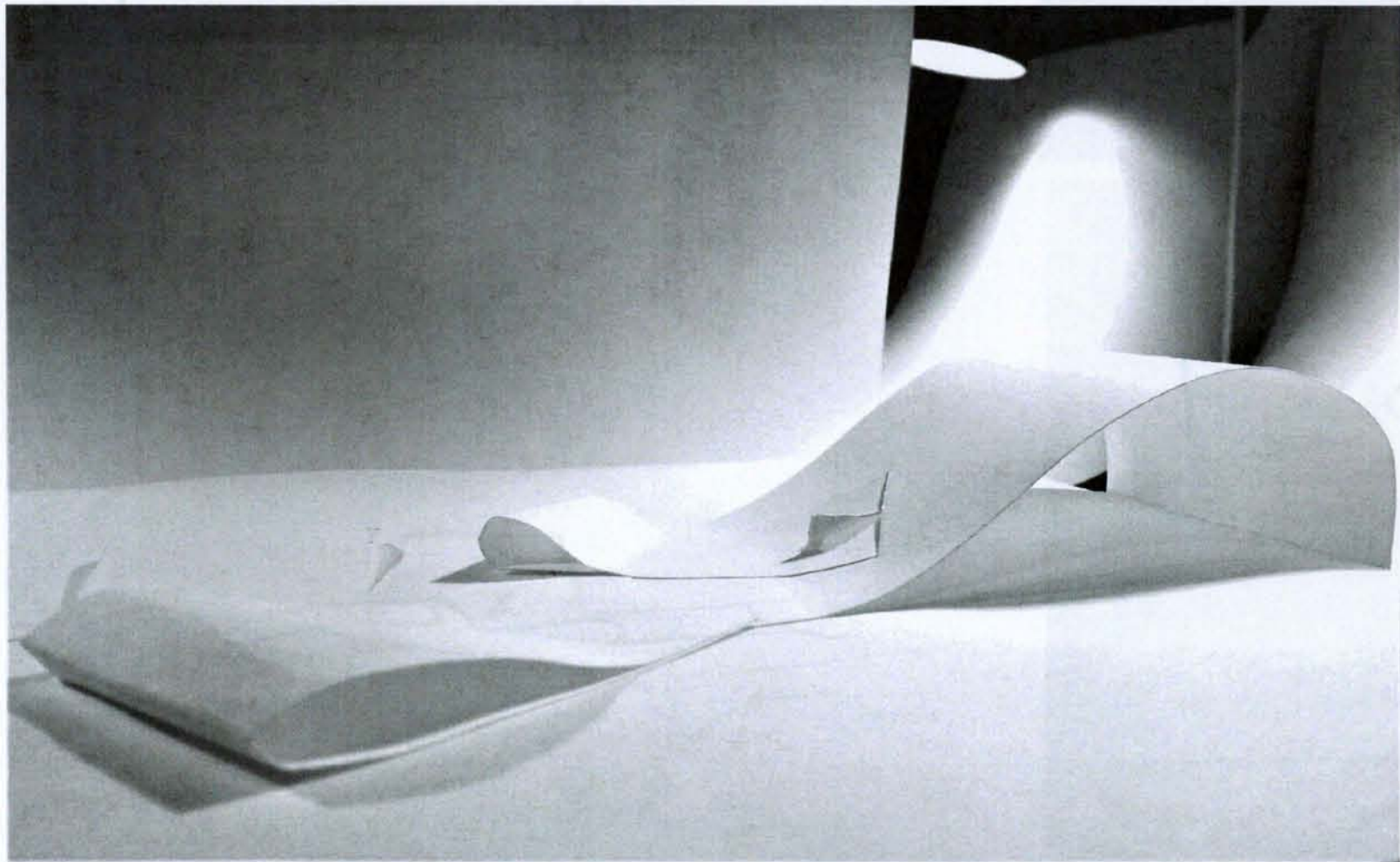
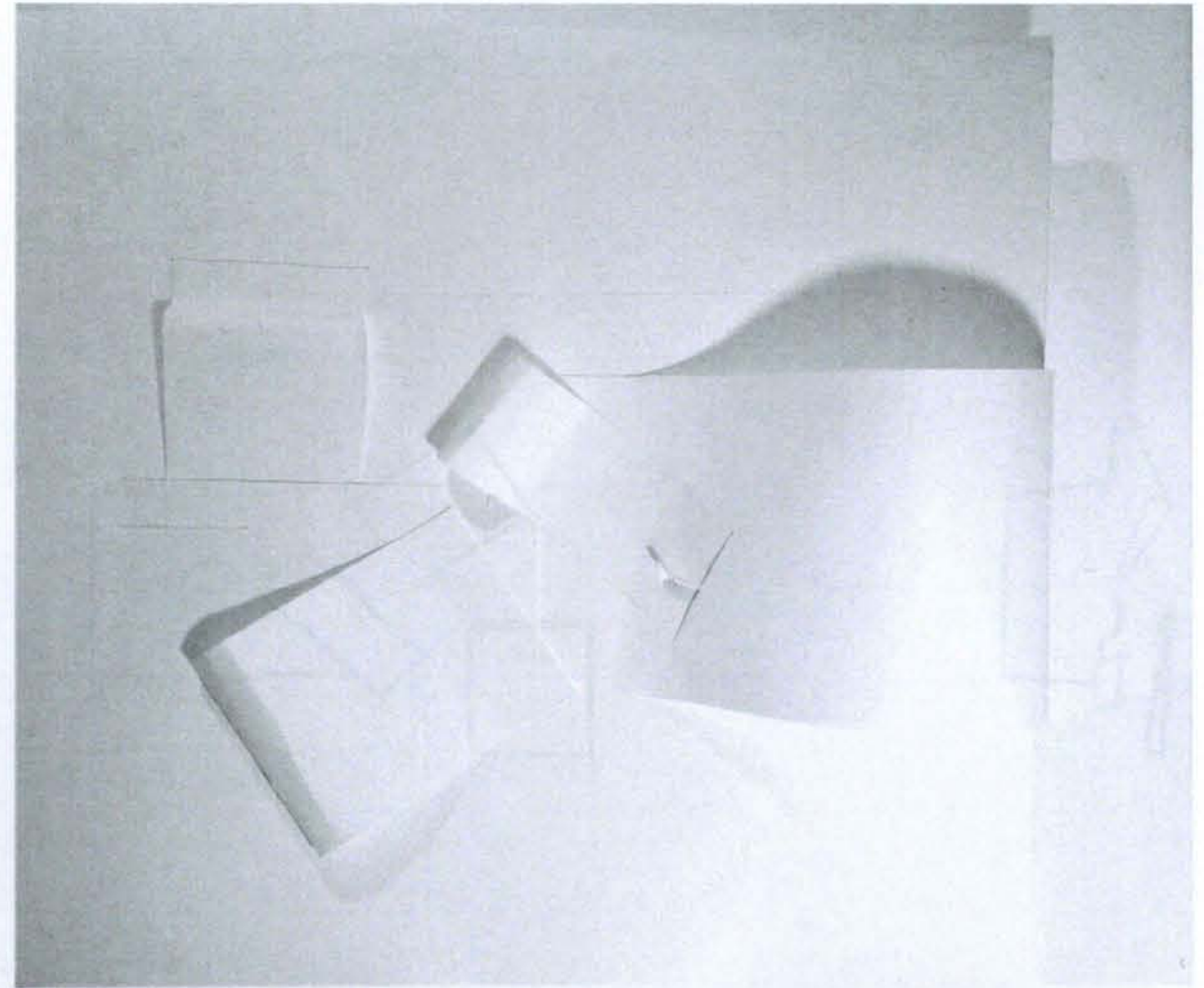
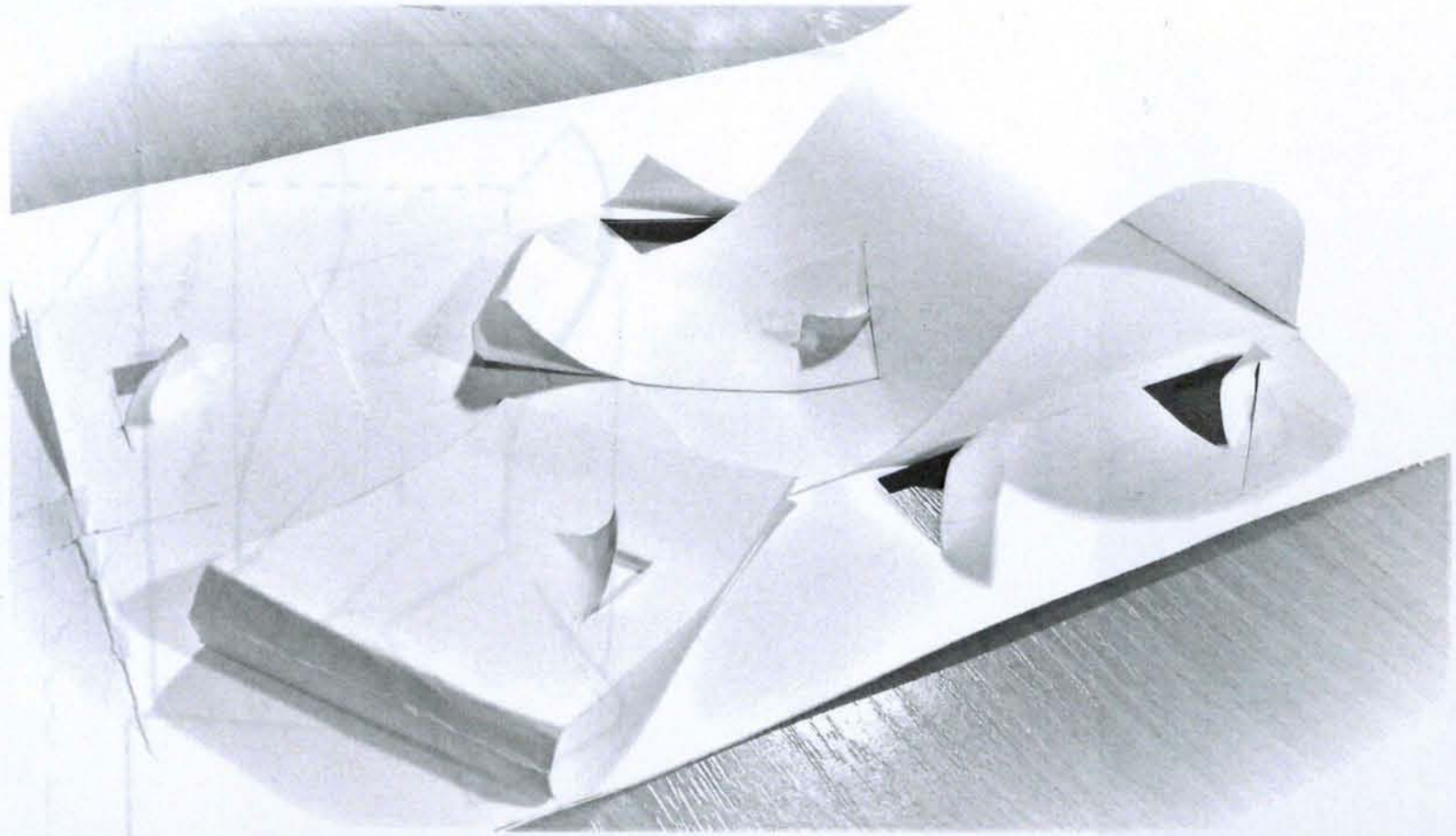

SKICE 1. MAKETE

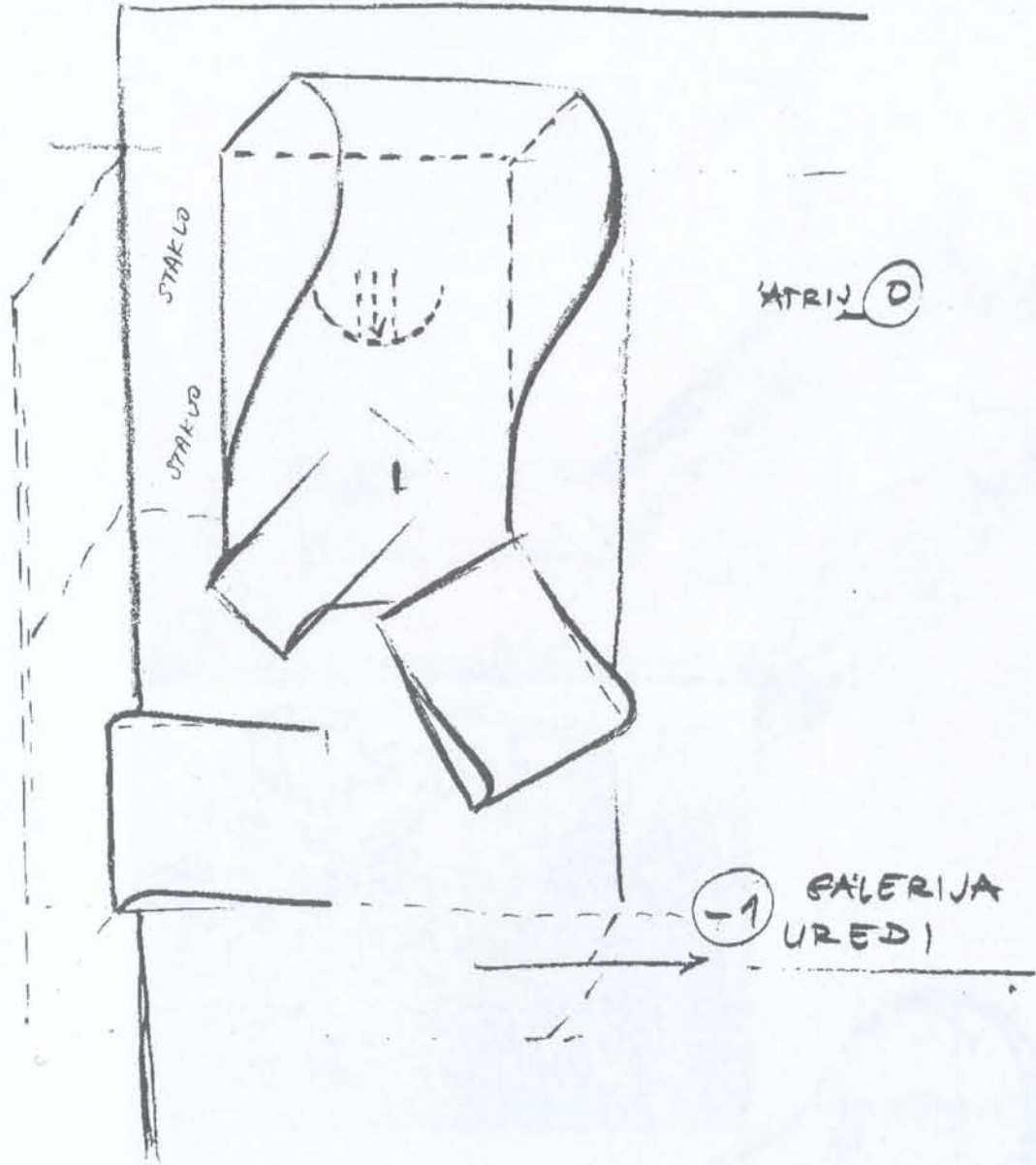

KOLEKCIJE
=

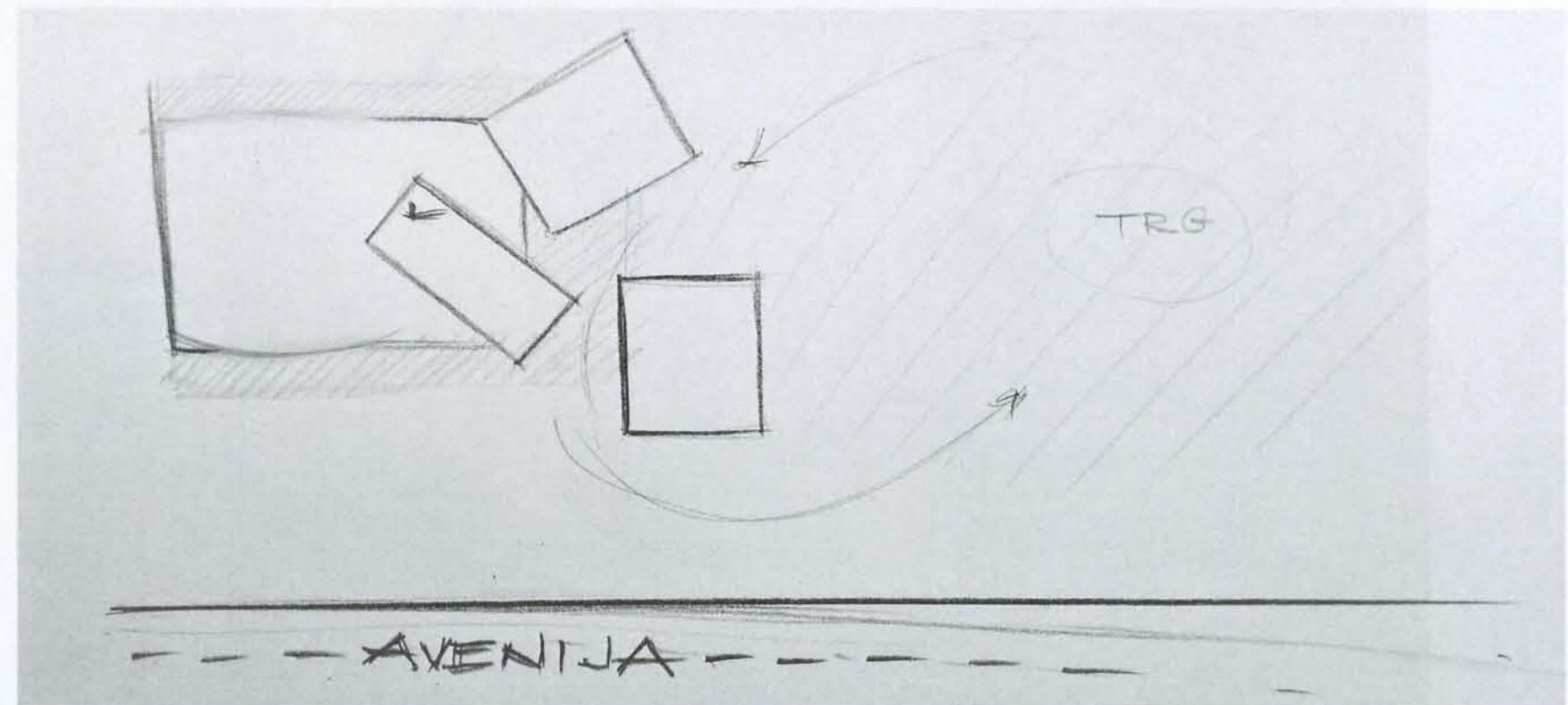
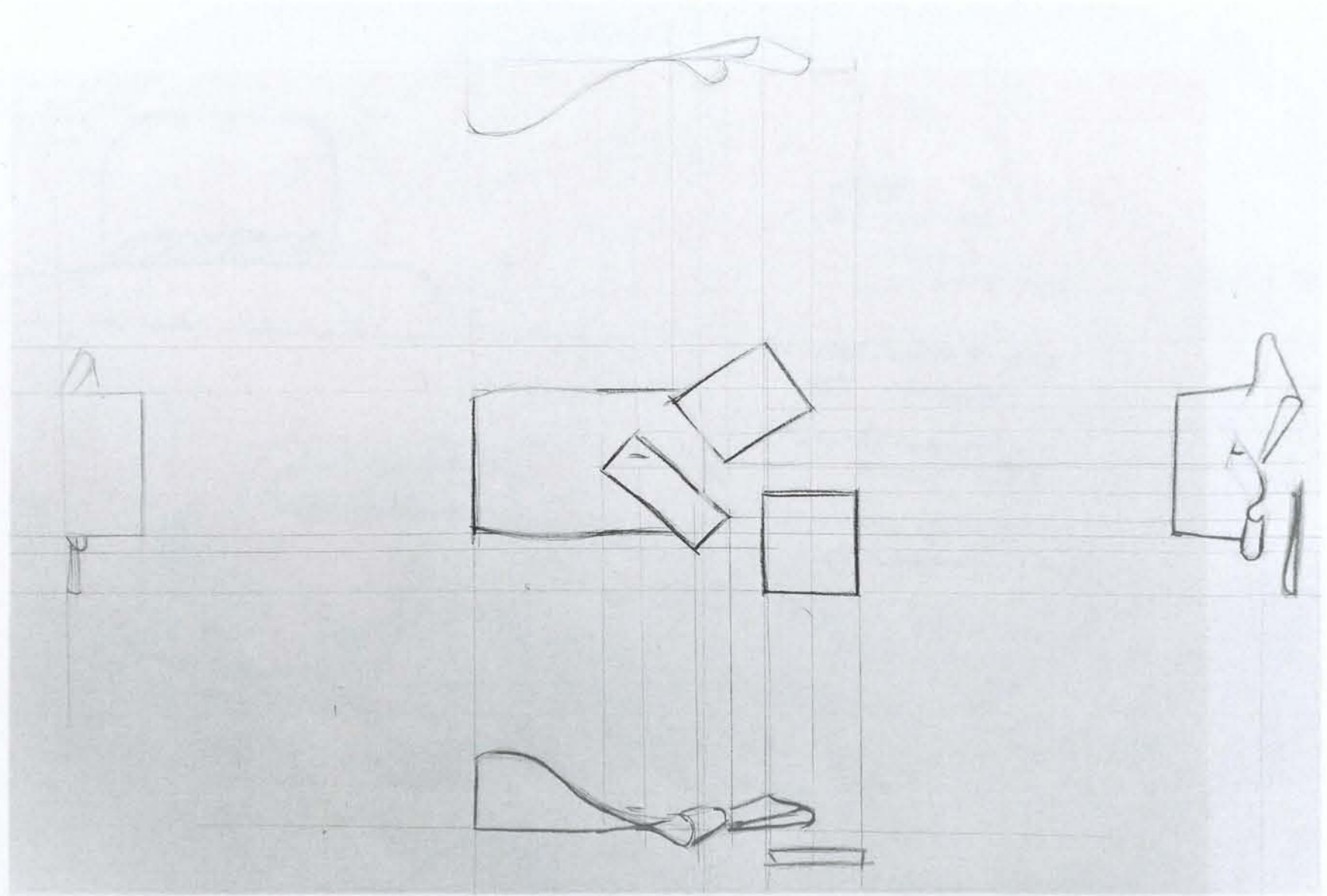

1. CRTEŽ PROSTORA

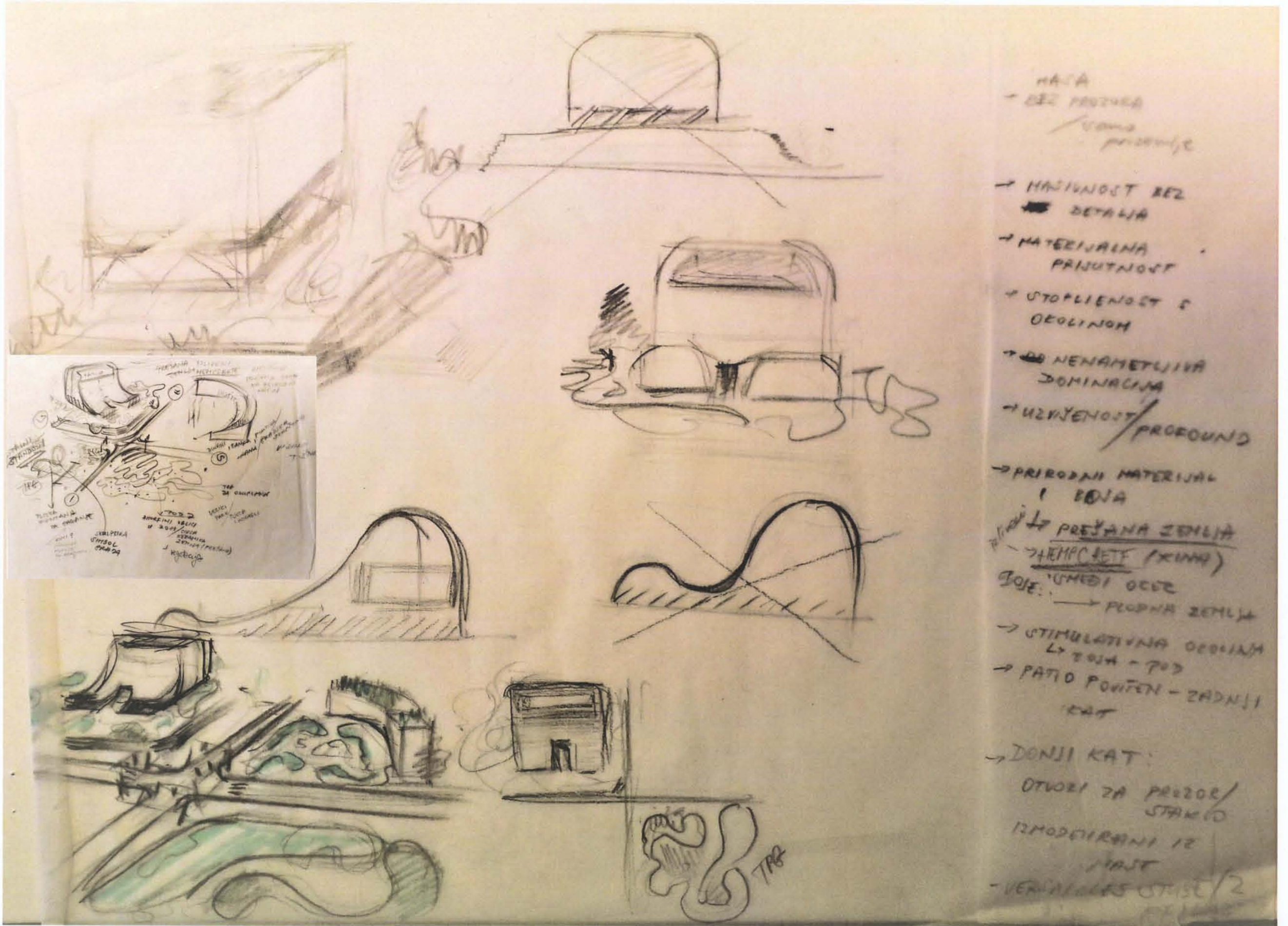

- HATA
- BEZ PROSTORA
- HAZIVNOST BEZ DETALJA
- MATERIJALNA PRIJUTNOST
- STOPLENOST S OČULINOM
- NEENAMETLJIVA DOMINACIJA
- UZVIŠENOST / PROFOUND
- PRIRODNI MATERIJAL I BOJA
- PREJANA ZEMLJA
- ZAHVATJEFT (KUNA)
- UMBE I OČE
- PLOPNA ZEMLJA
- STIMULATIVNA OČULINA
- BOJA - 703
- PATIO POVIŠEN - ZADNJI KAT
- DONJI KAT:
- OTVORI ZA PRIZOR / STAKLO
- MODERIRANI IZ PASTE
- VERIGLES STISE / 2

LAURA DUSPER

OSNOVE
ARHITEKTONSKOG
PROJEKTIRANJA



Mentori: izv. prof. art. Stanko Stergaršek, d.i.a.,
asistent Aneta Mudronja Pletenac, d.i.a.



STUDIJ KRAJOBRAZNA
ARHITEKTURA - 1. semestar Bs –
ak.god. 2020./21.

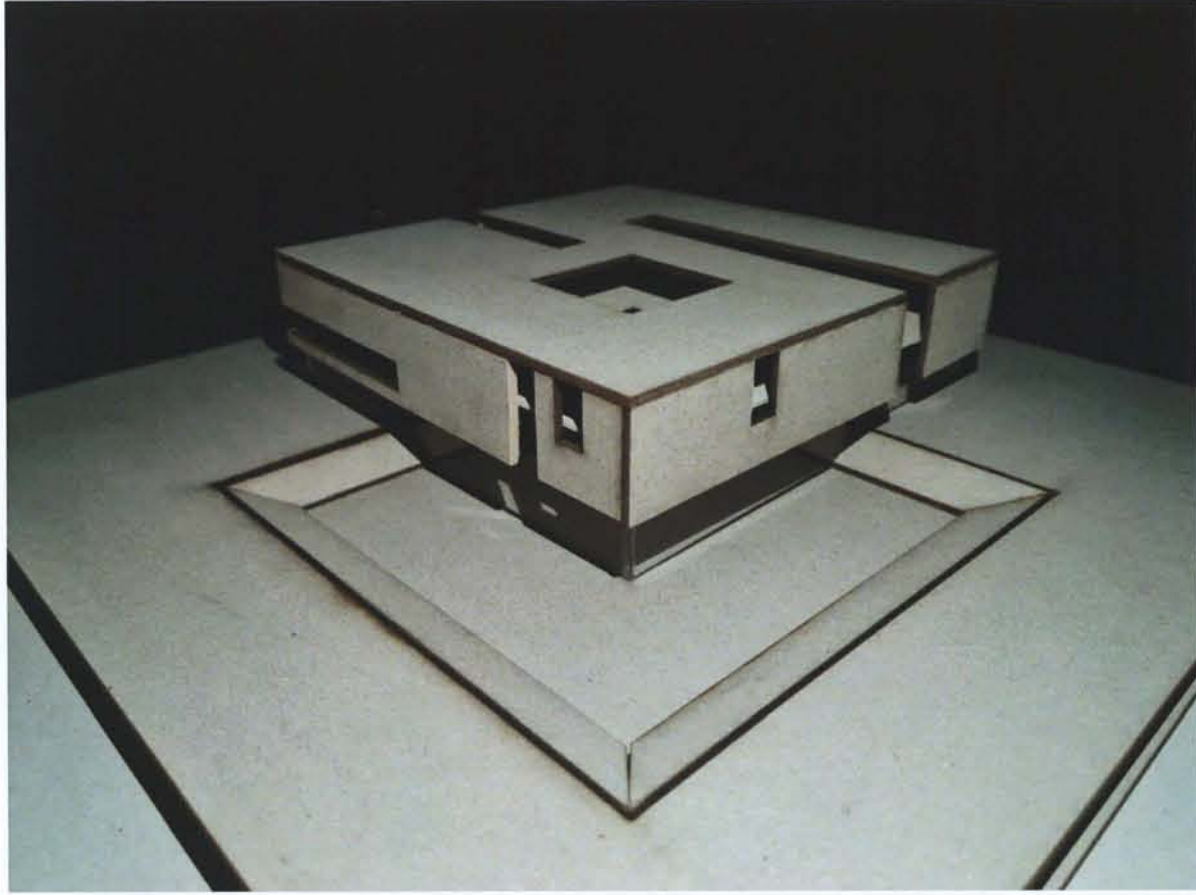

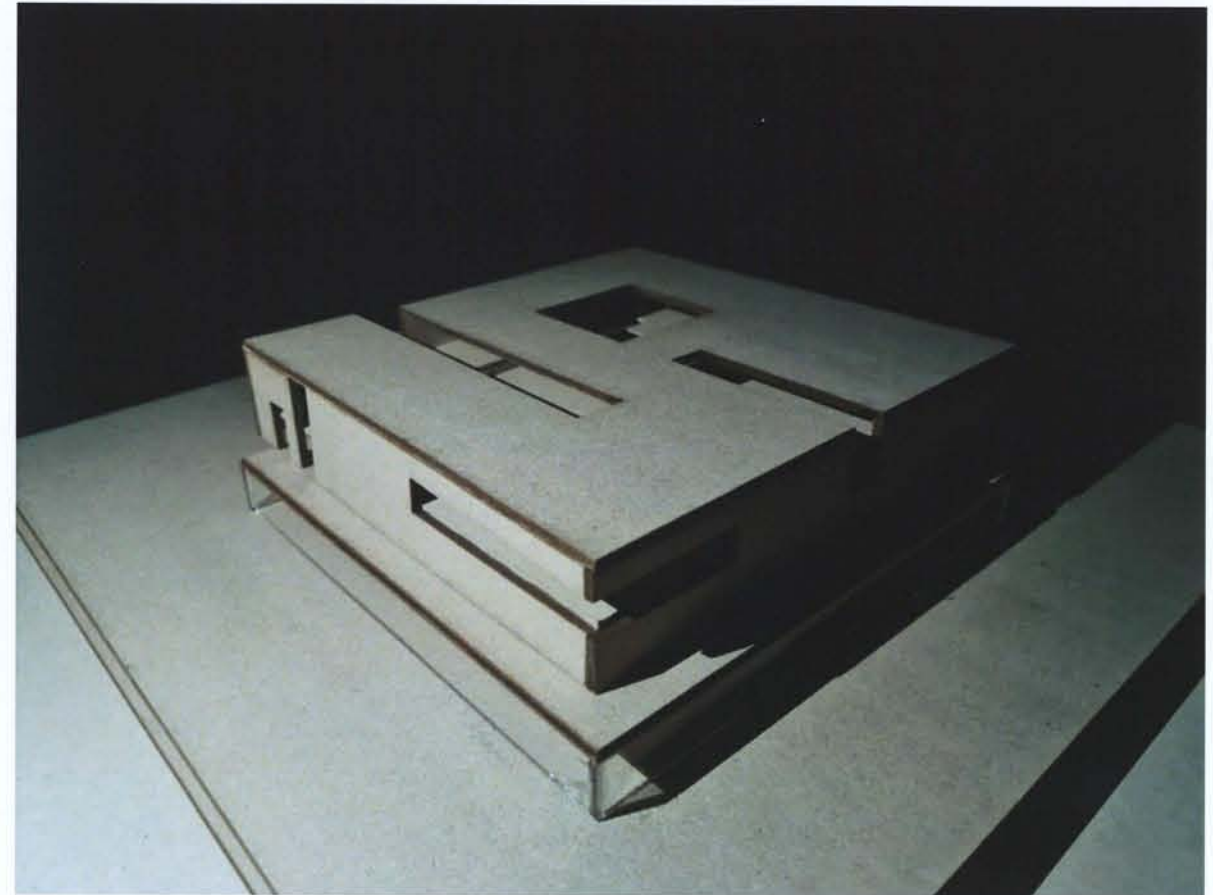
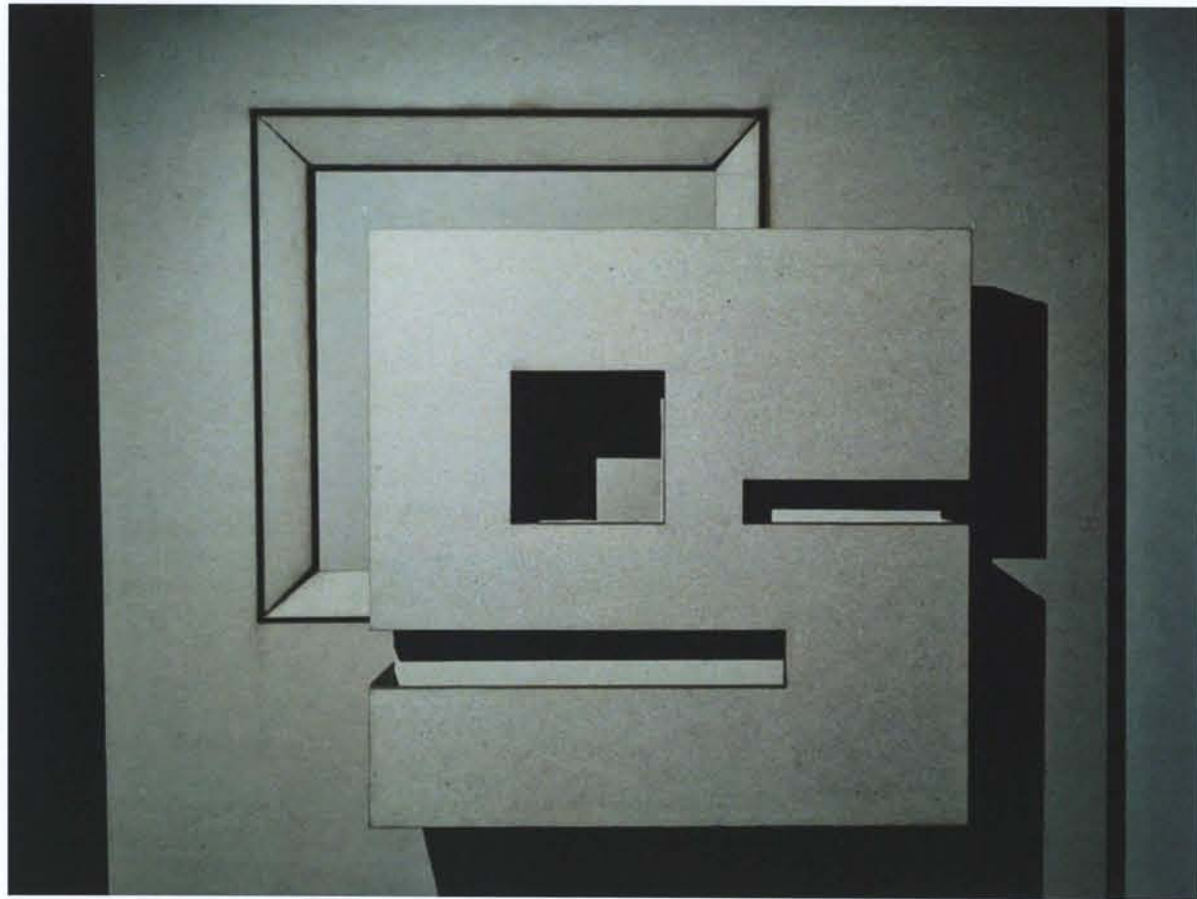

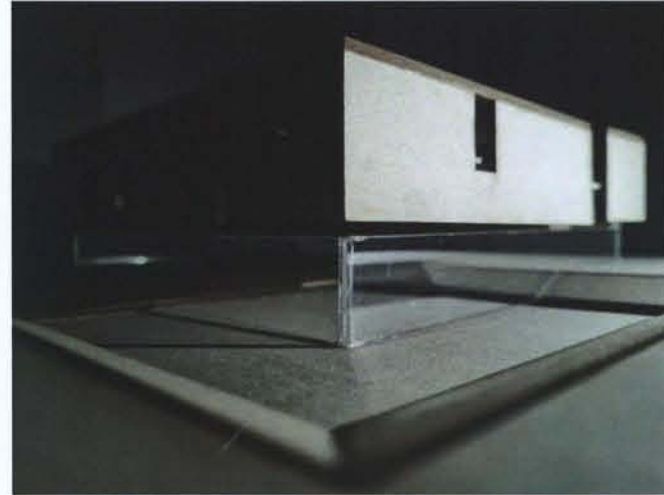
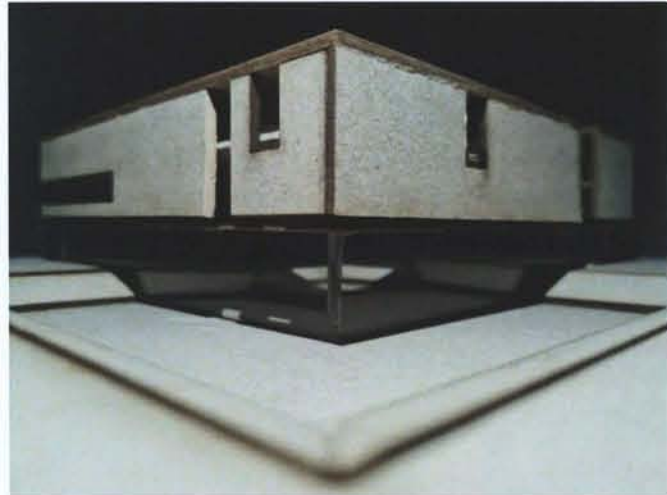

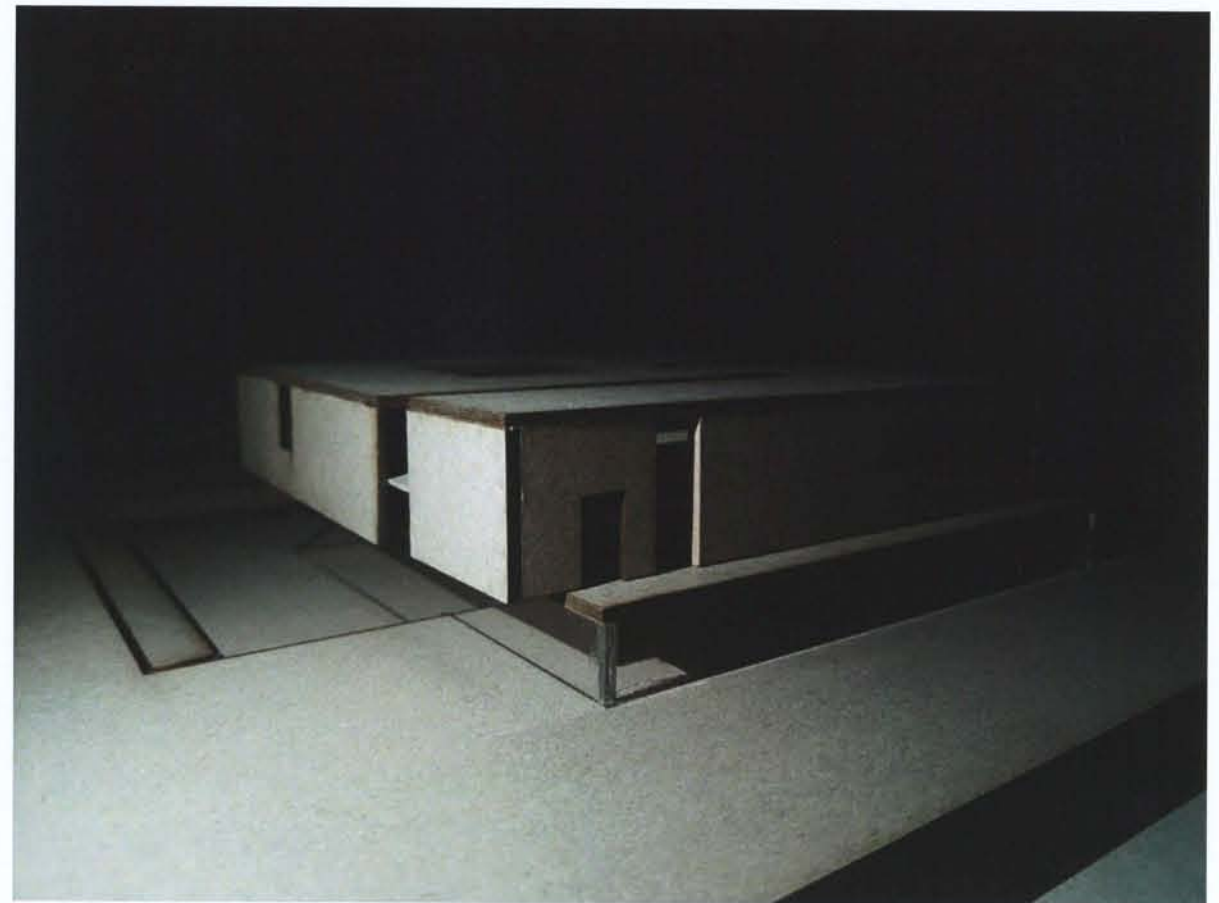
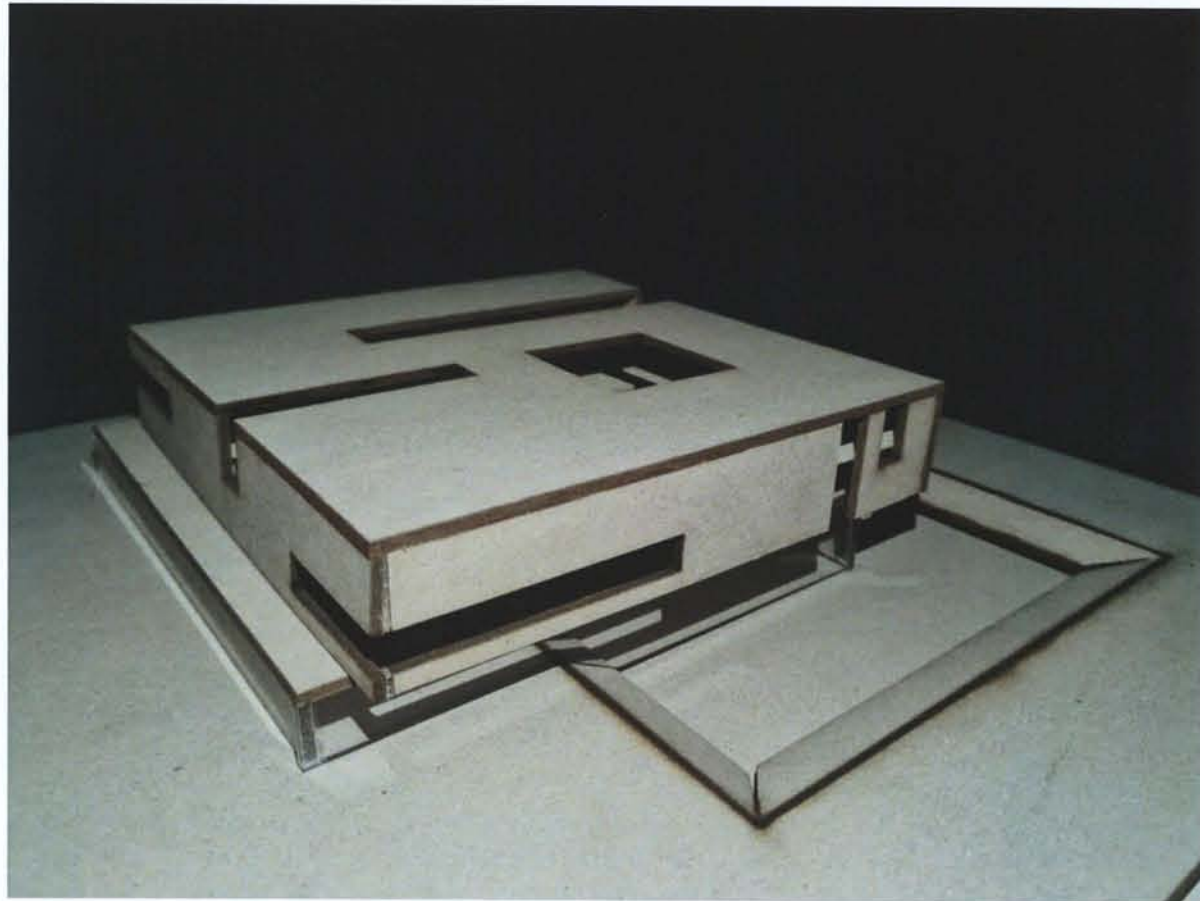

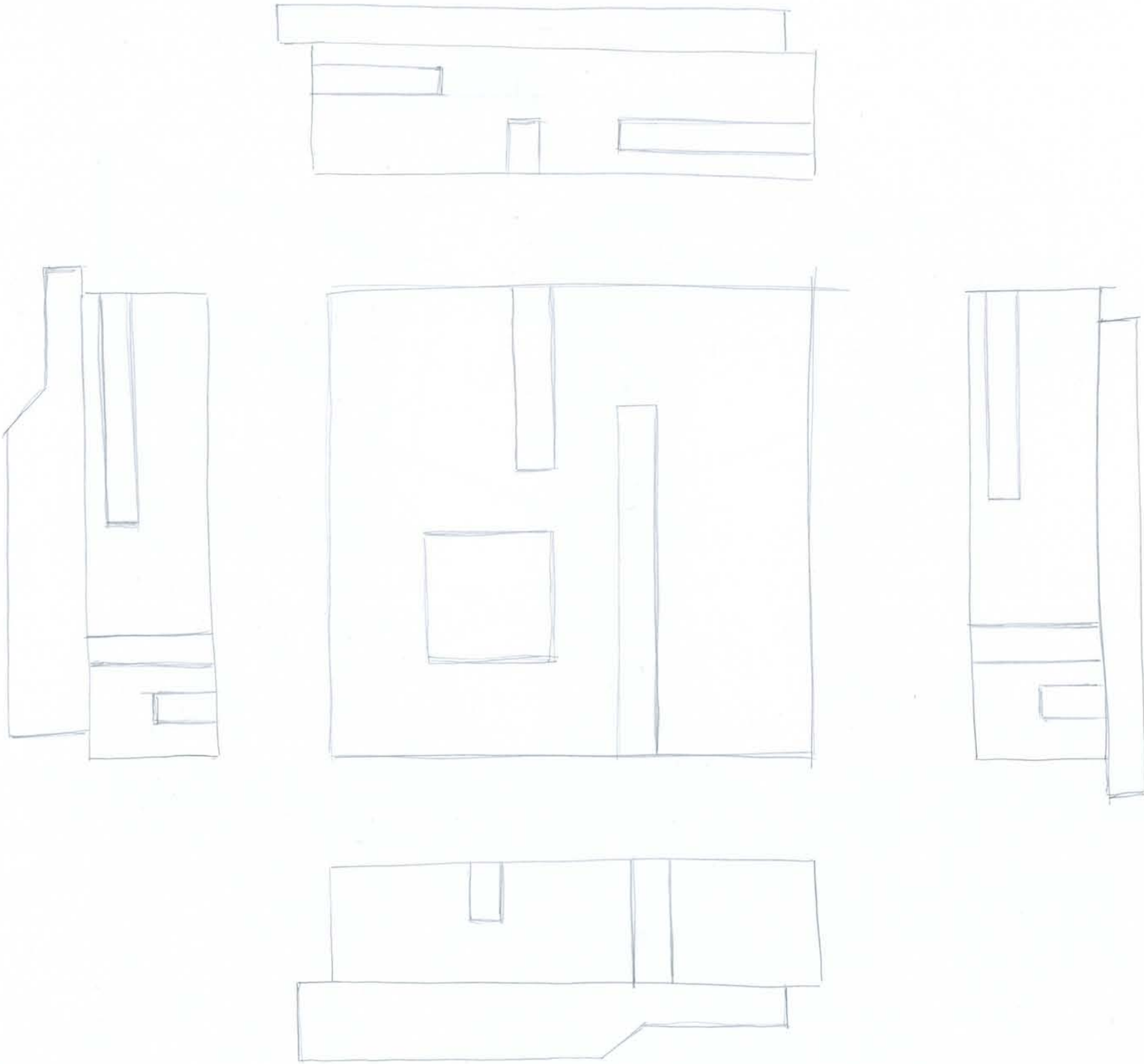

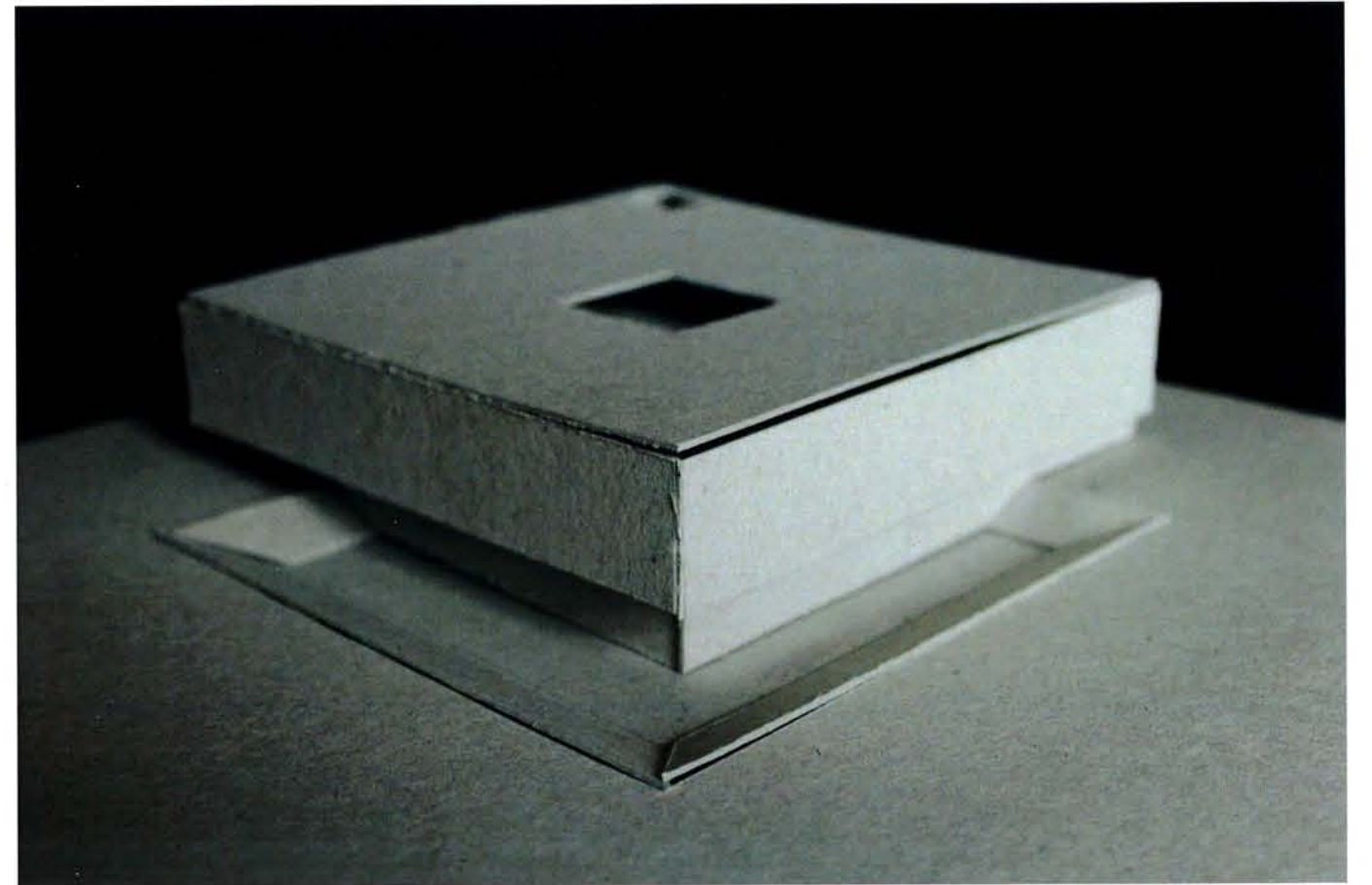
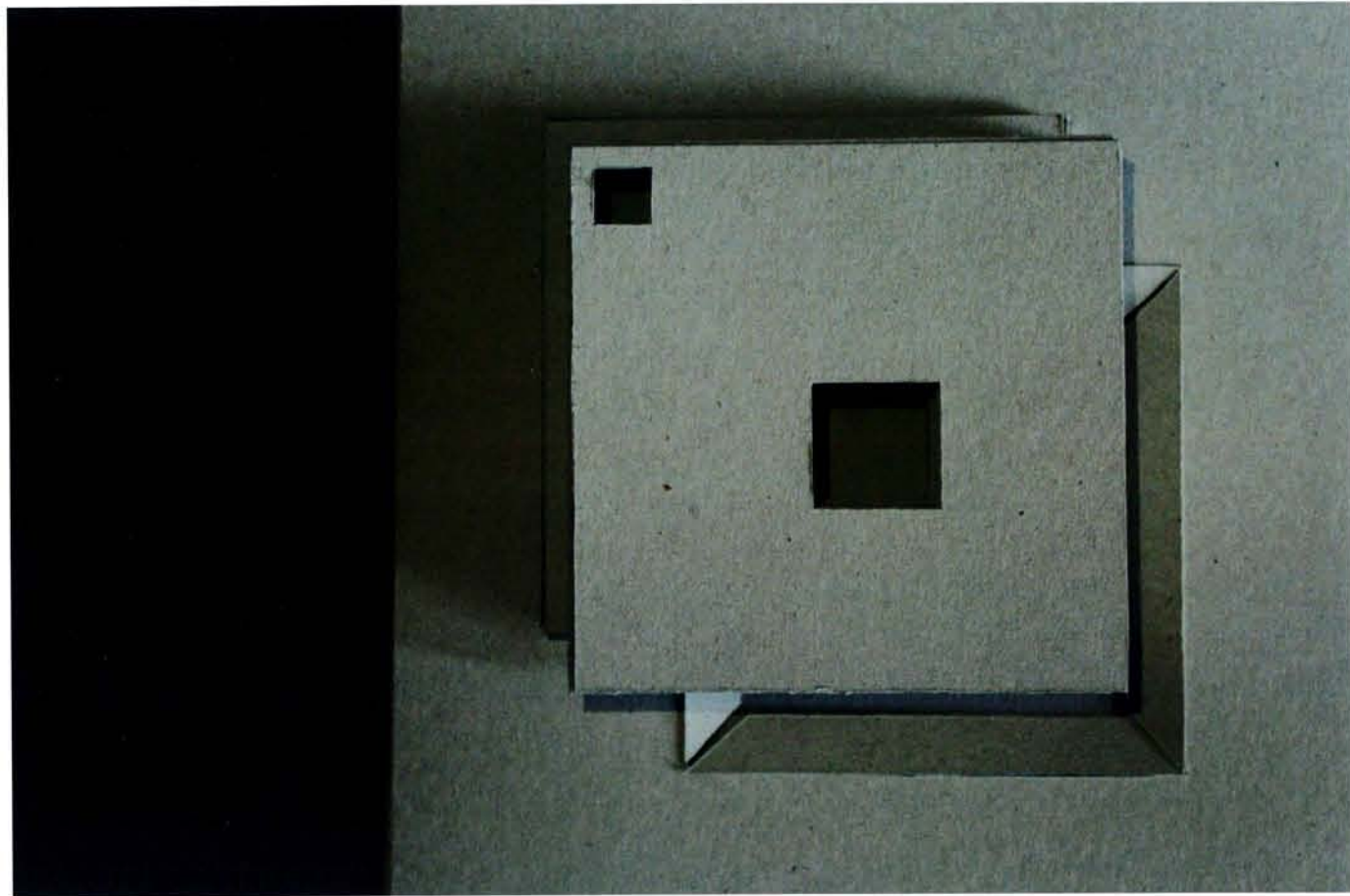

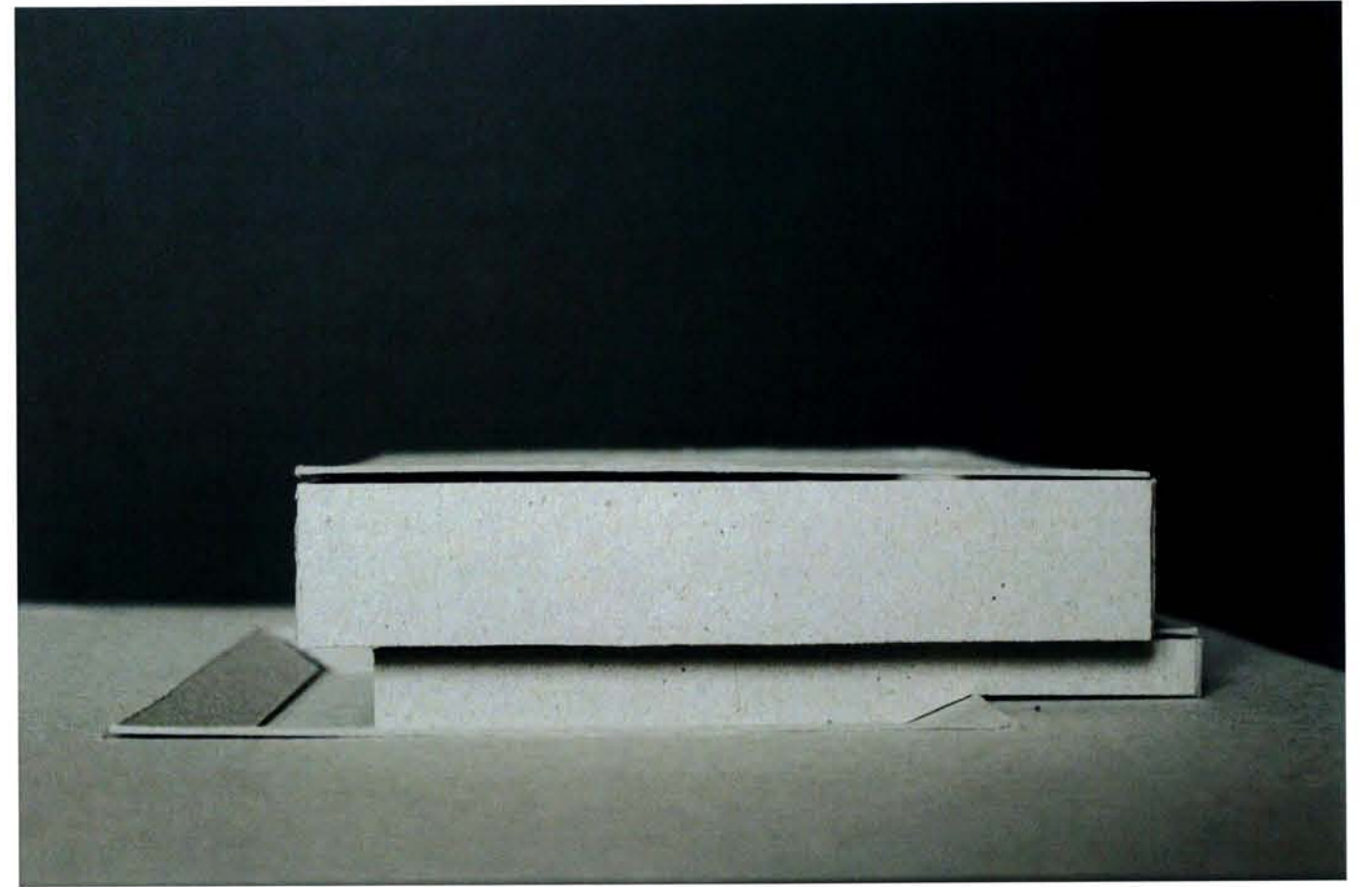
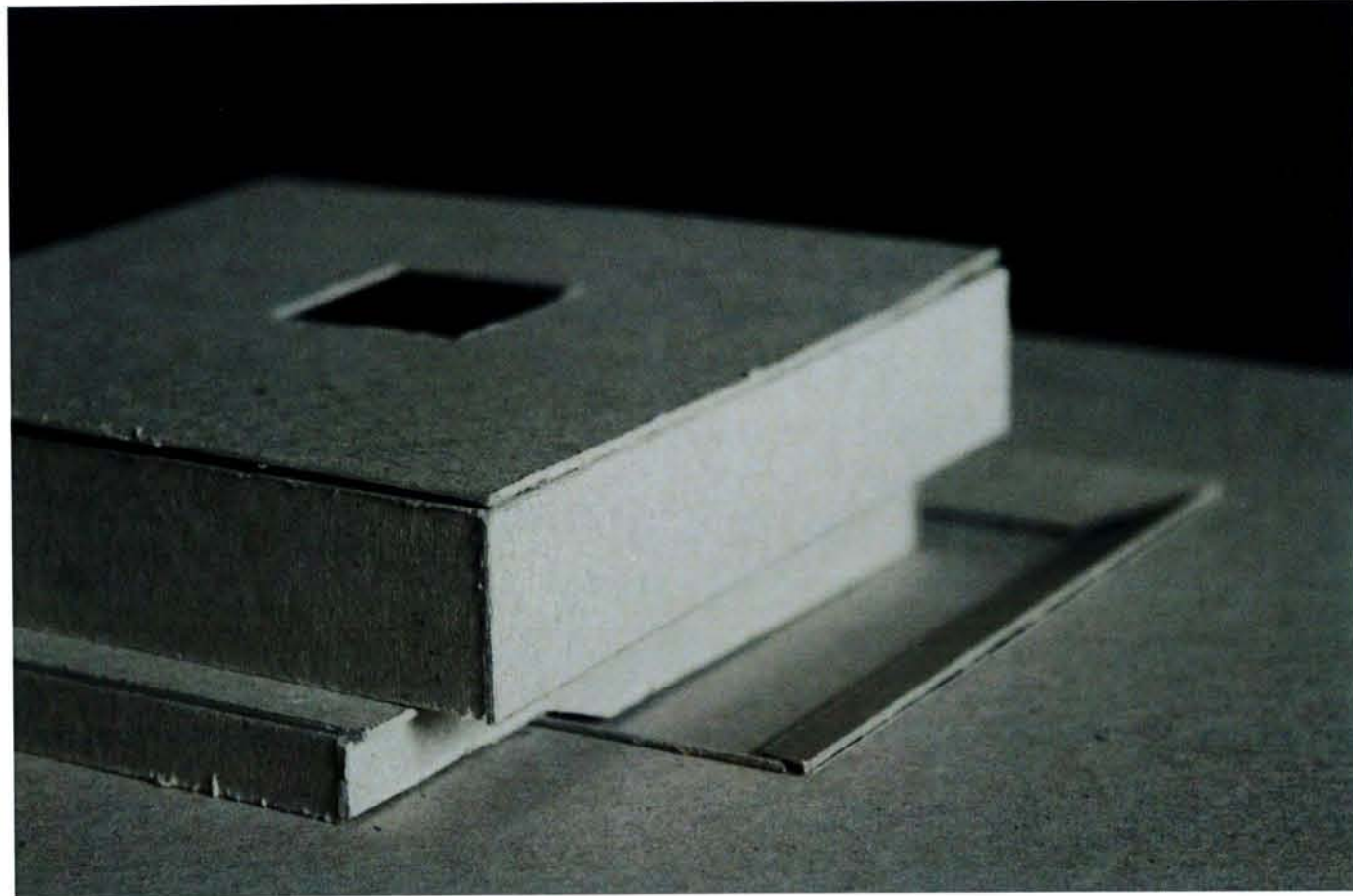

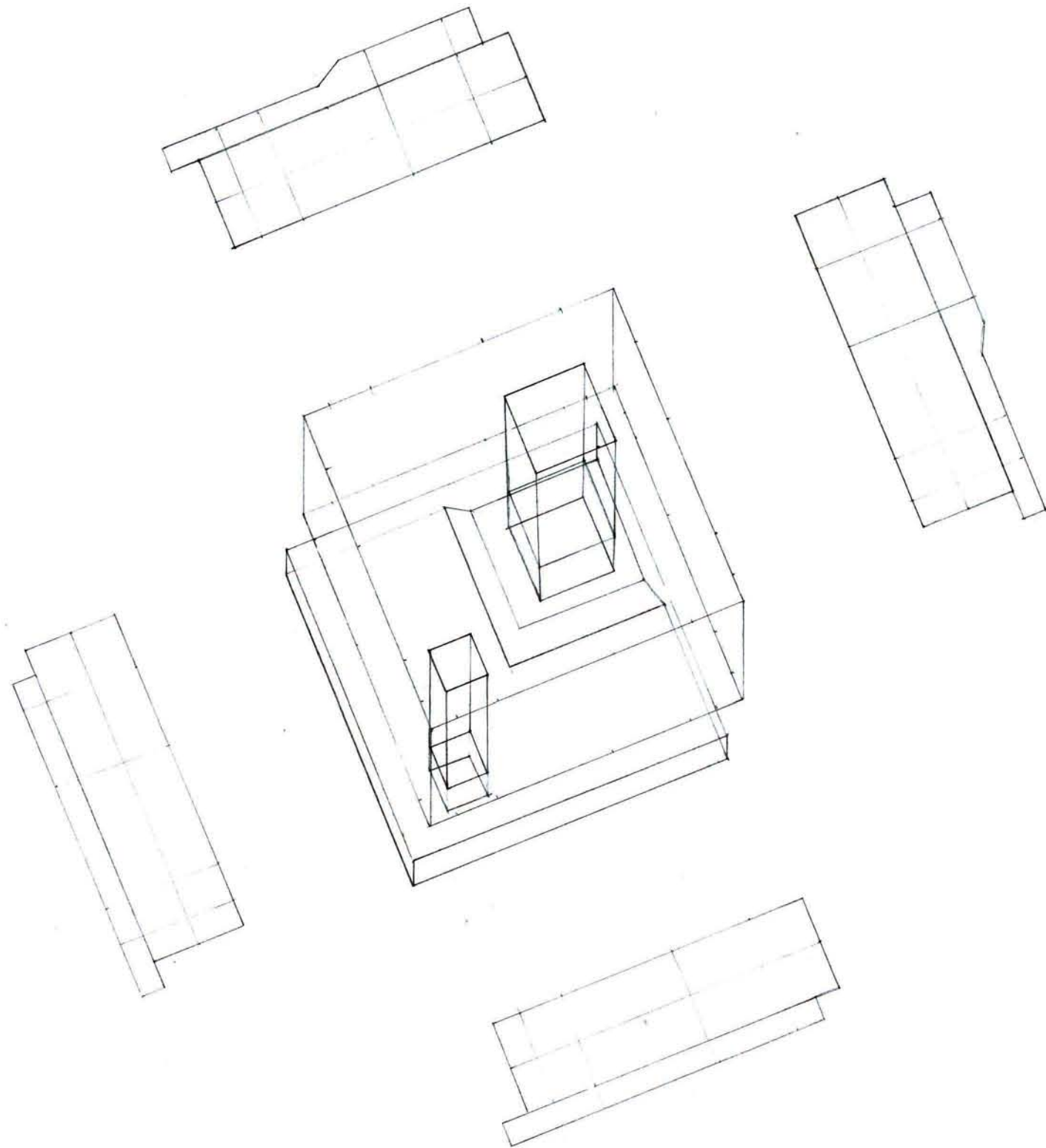

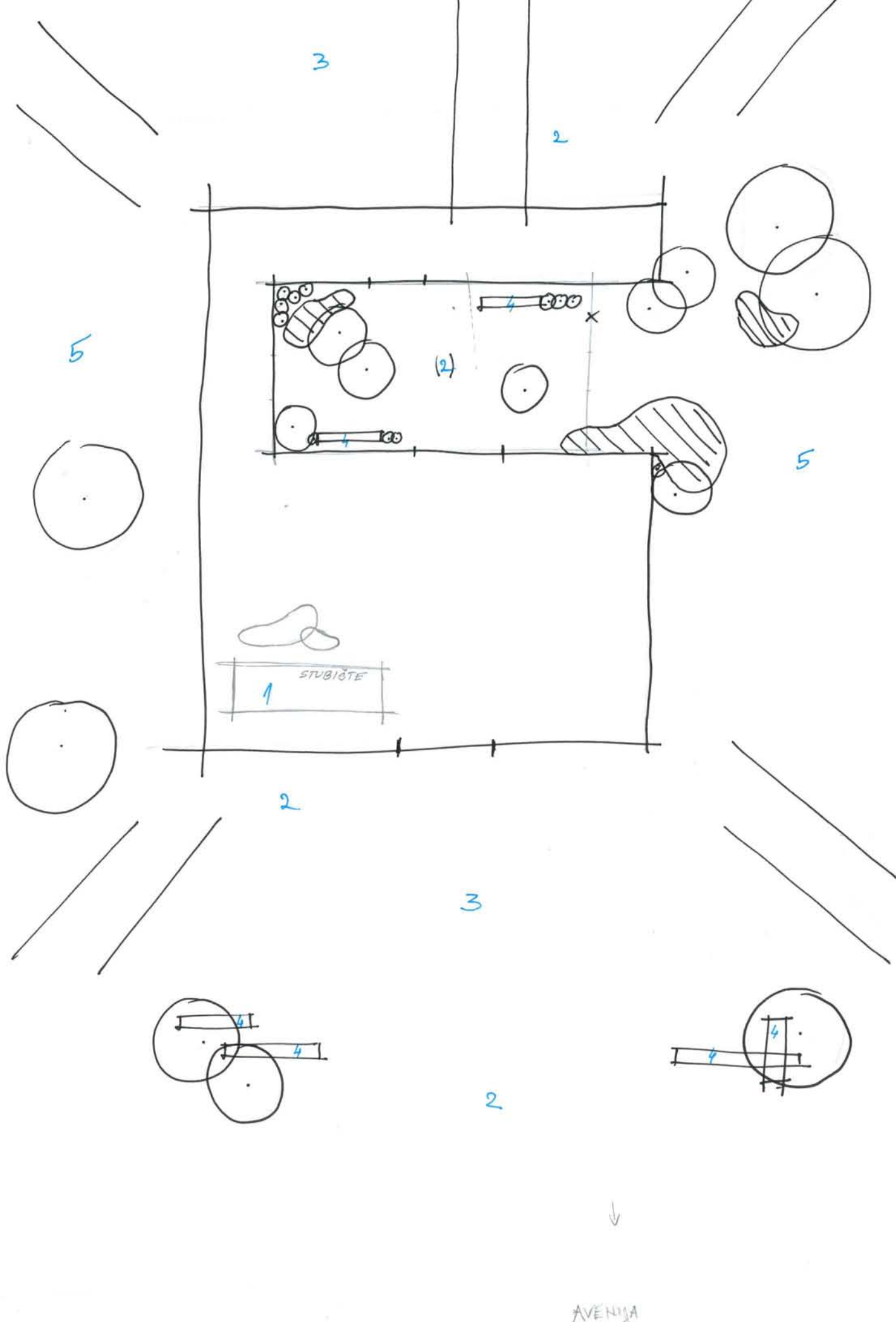

TRG
↑ →

- 1 - ZGRADA
- 2 - OPLOČENJE
- 3 - STUBIŠTE
- 4 - KUPE
- 5 - ŠIROKO STUBIŠTE

LAURA DUSPER, KA

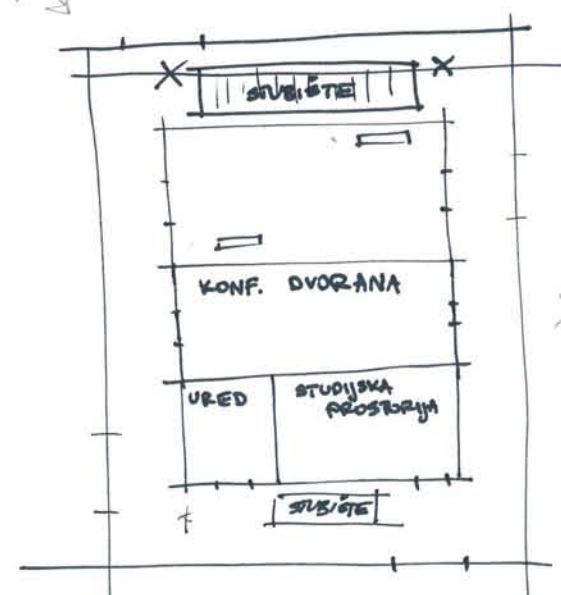
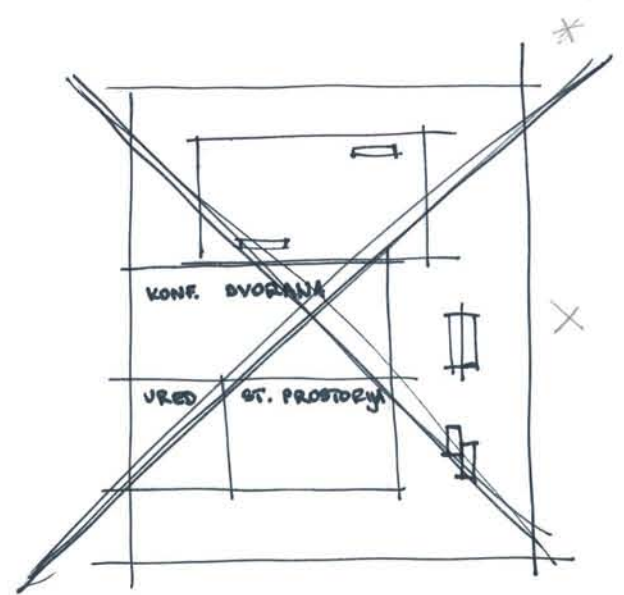
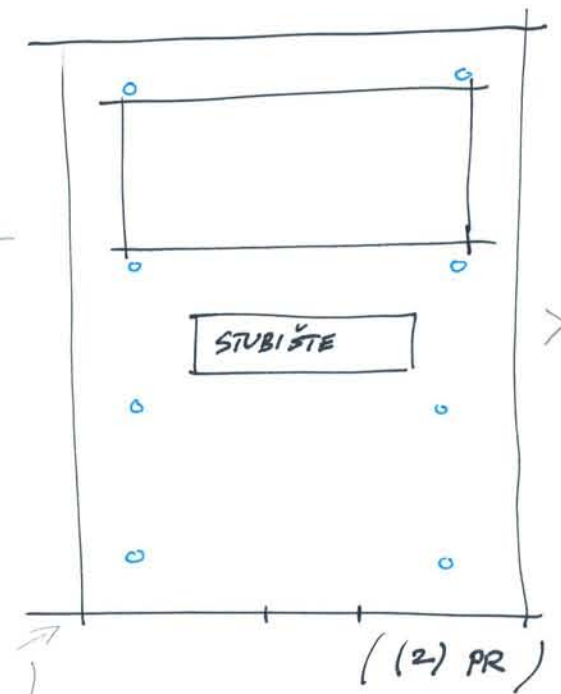
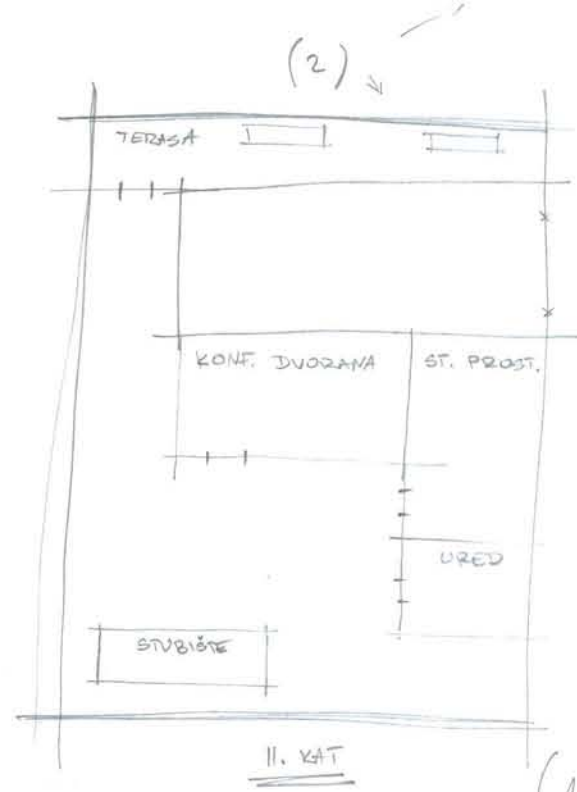
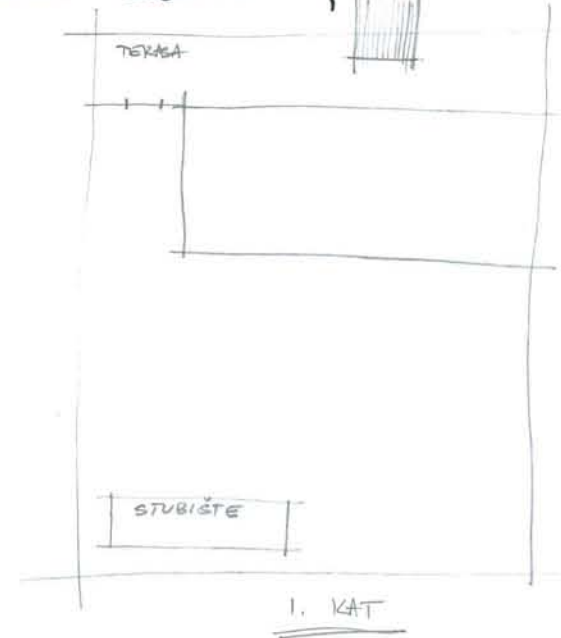

AVENIJA

LAURA DUSPER

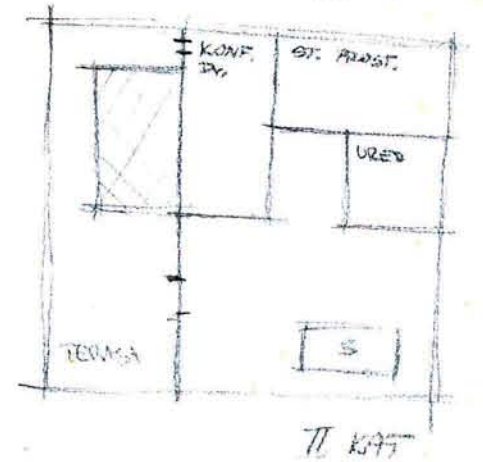
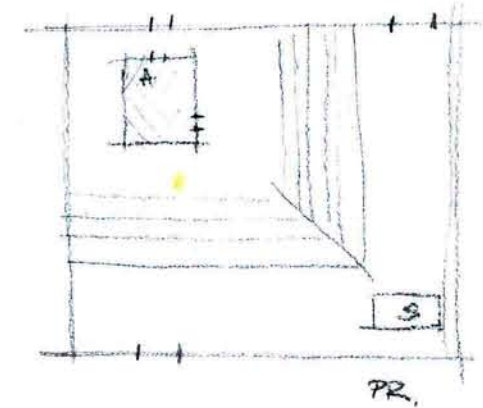
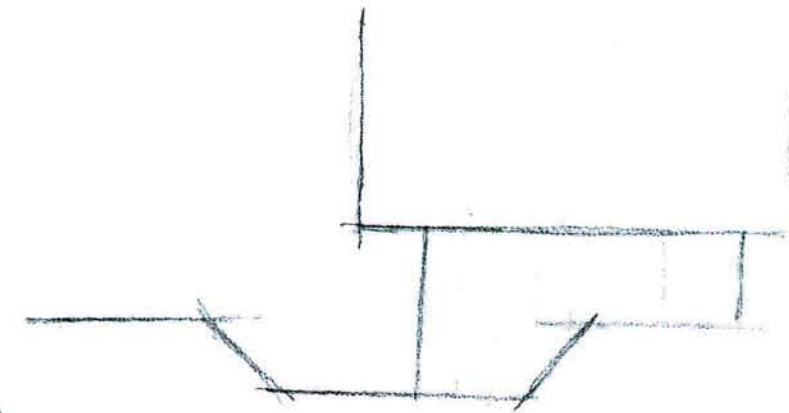
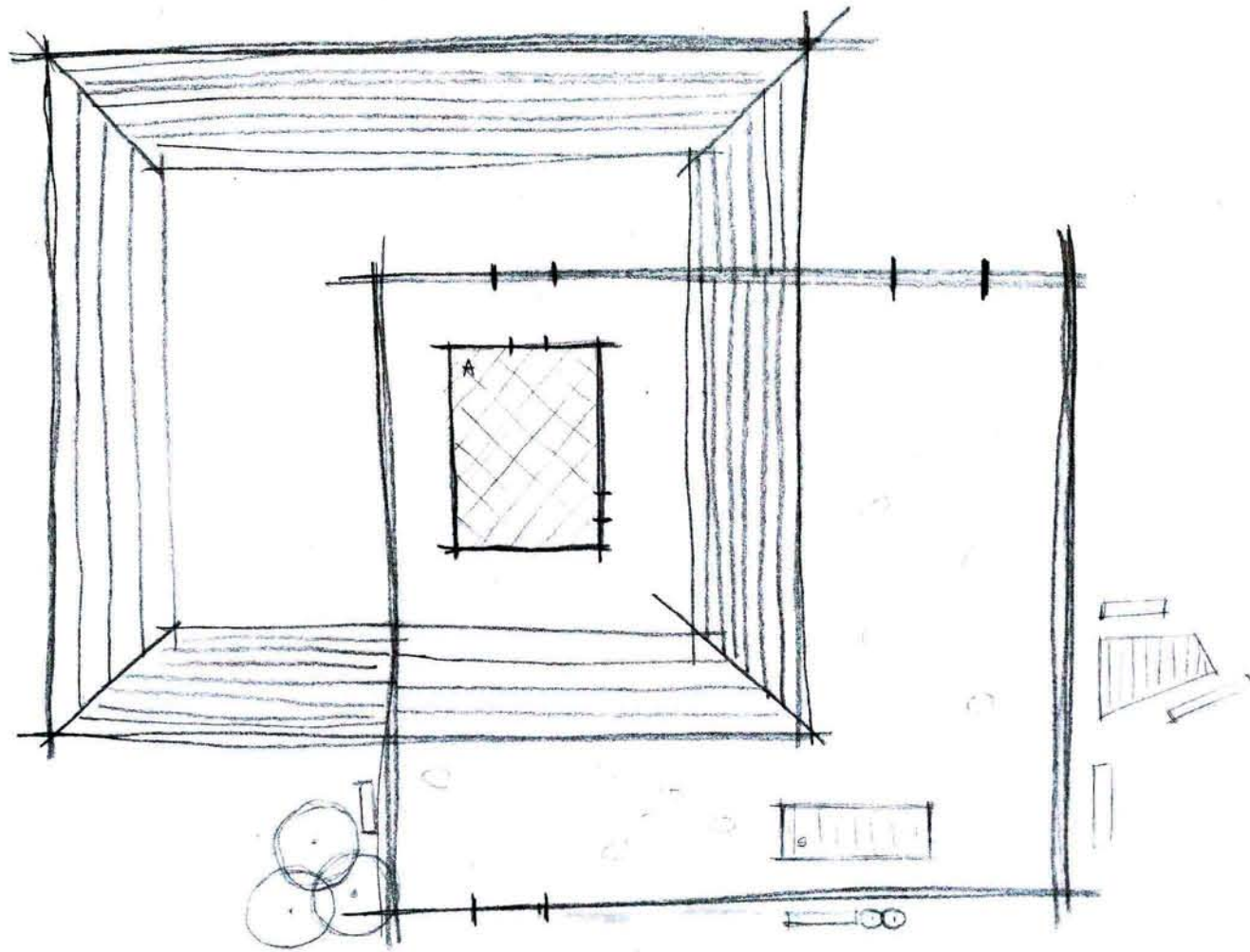
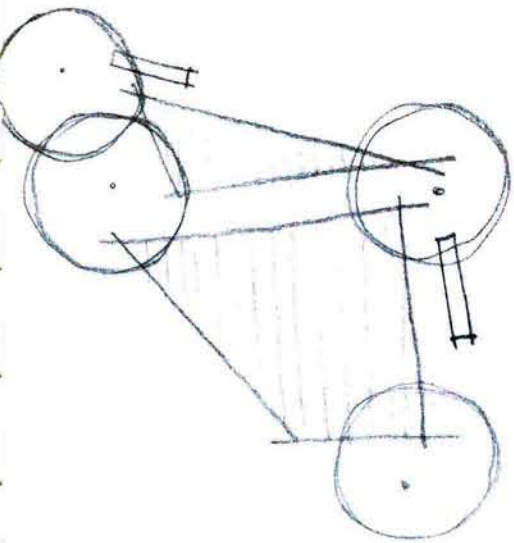
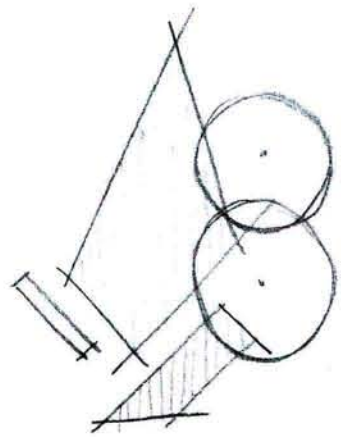
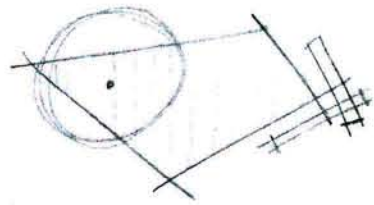
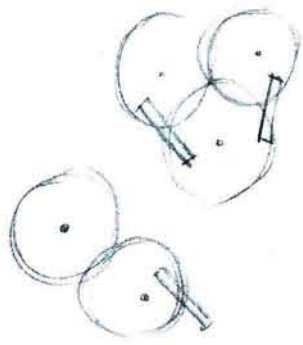

GL. GALERIJA

AVENIJA

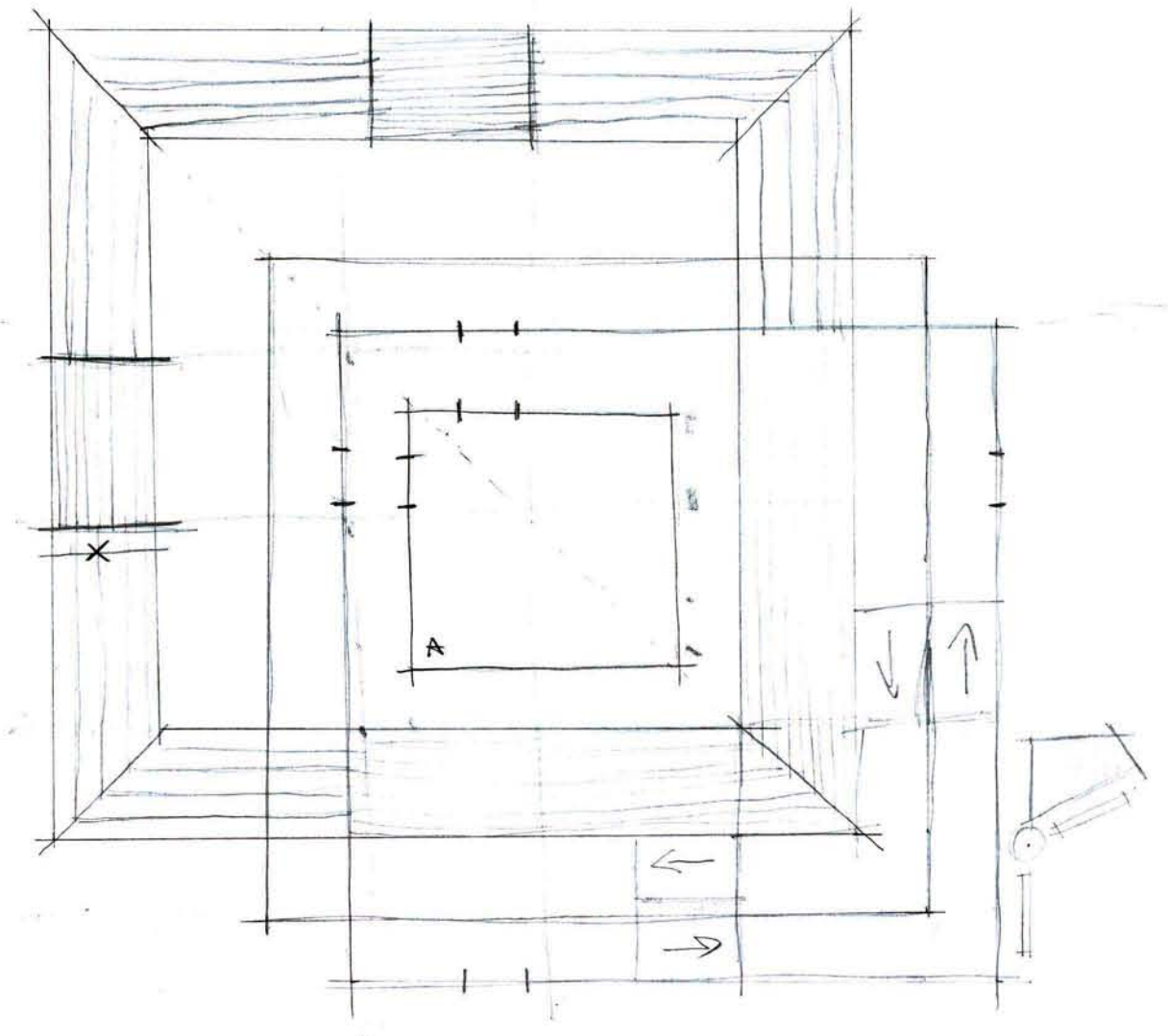
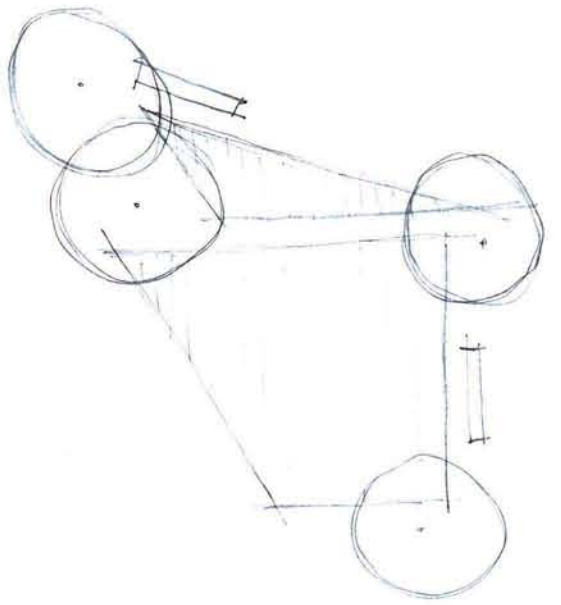
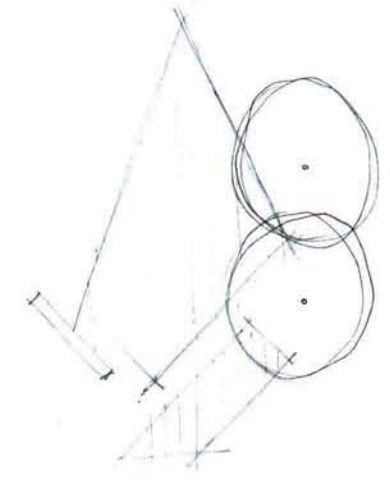
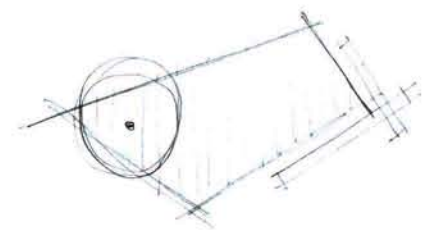
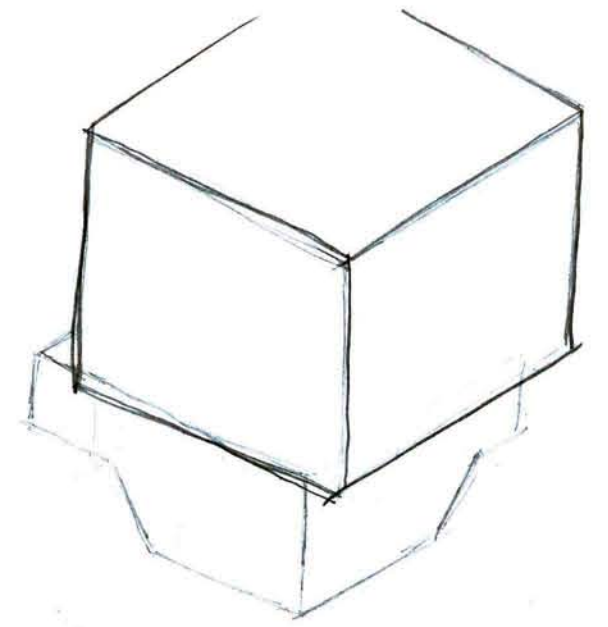

AVENIDA

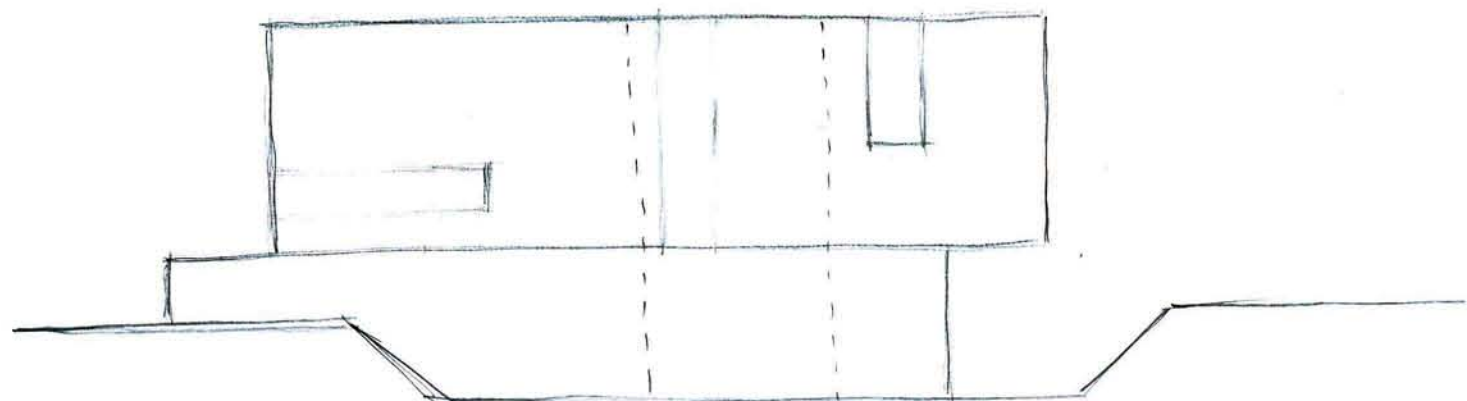
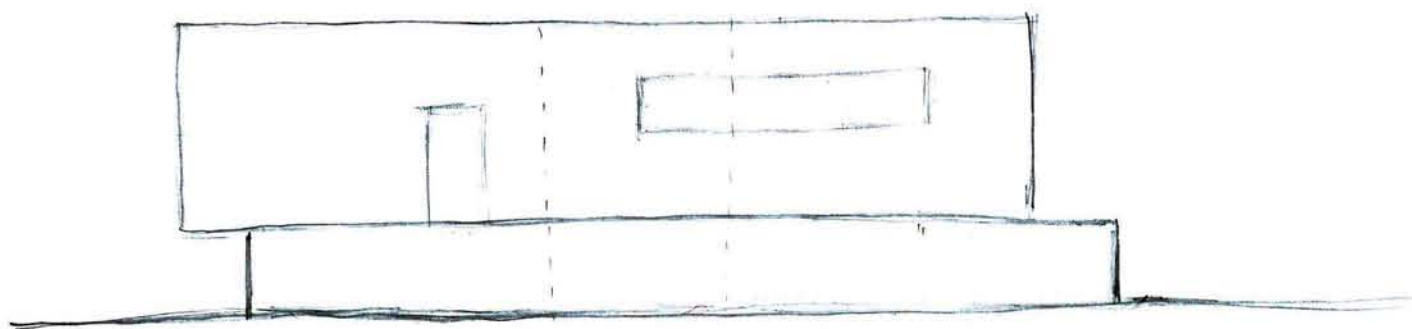
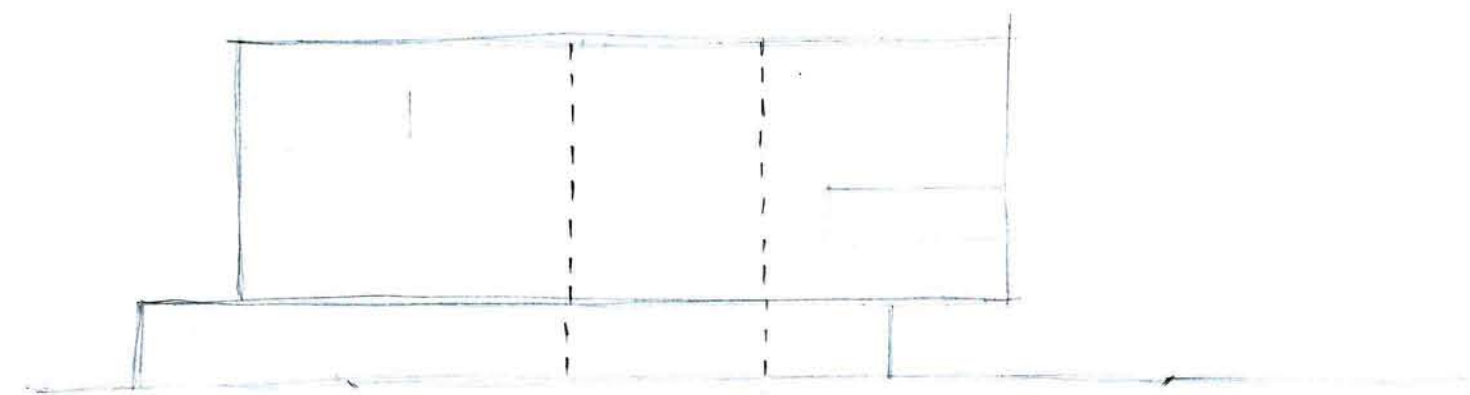
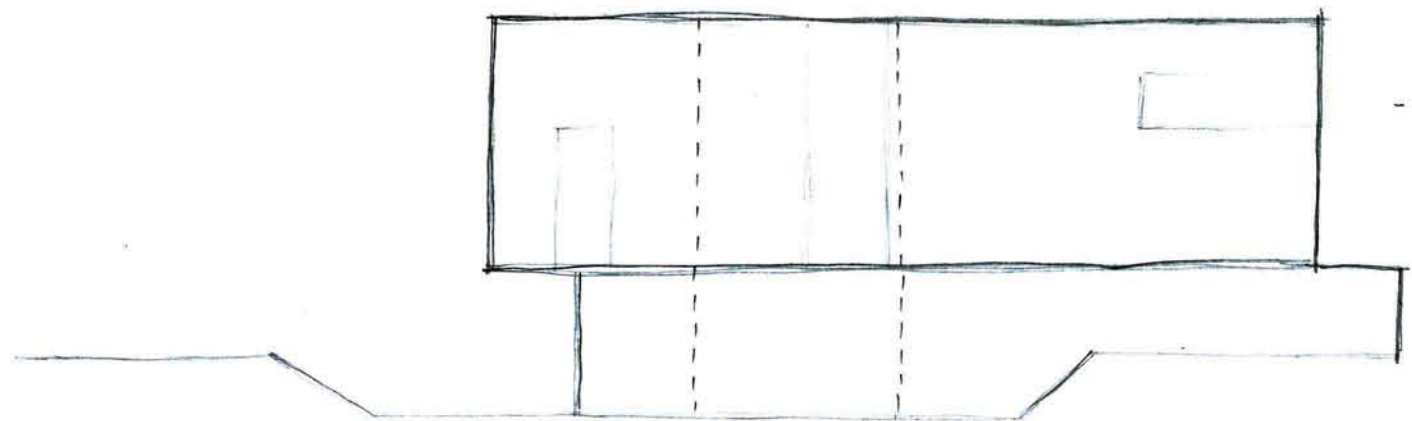

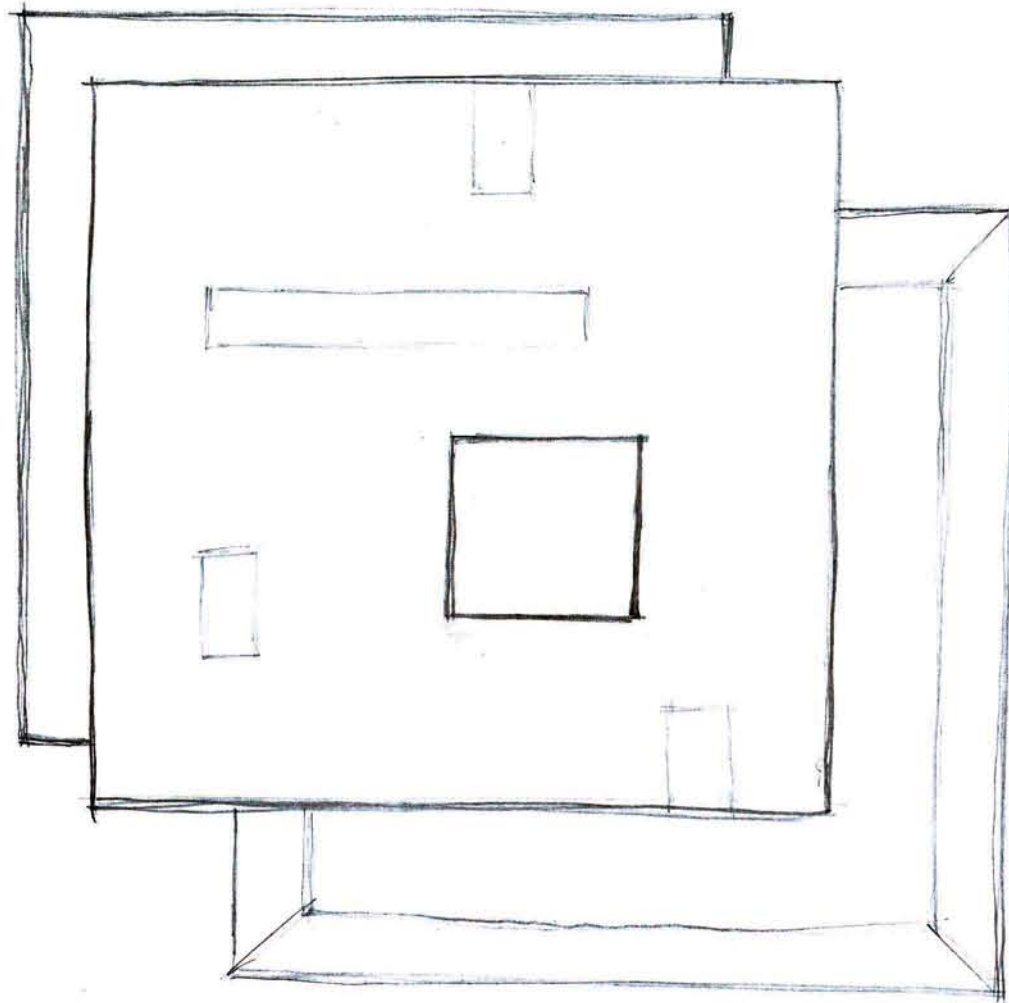



TRG

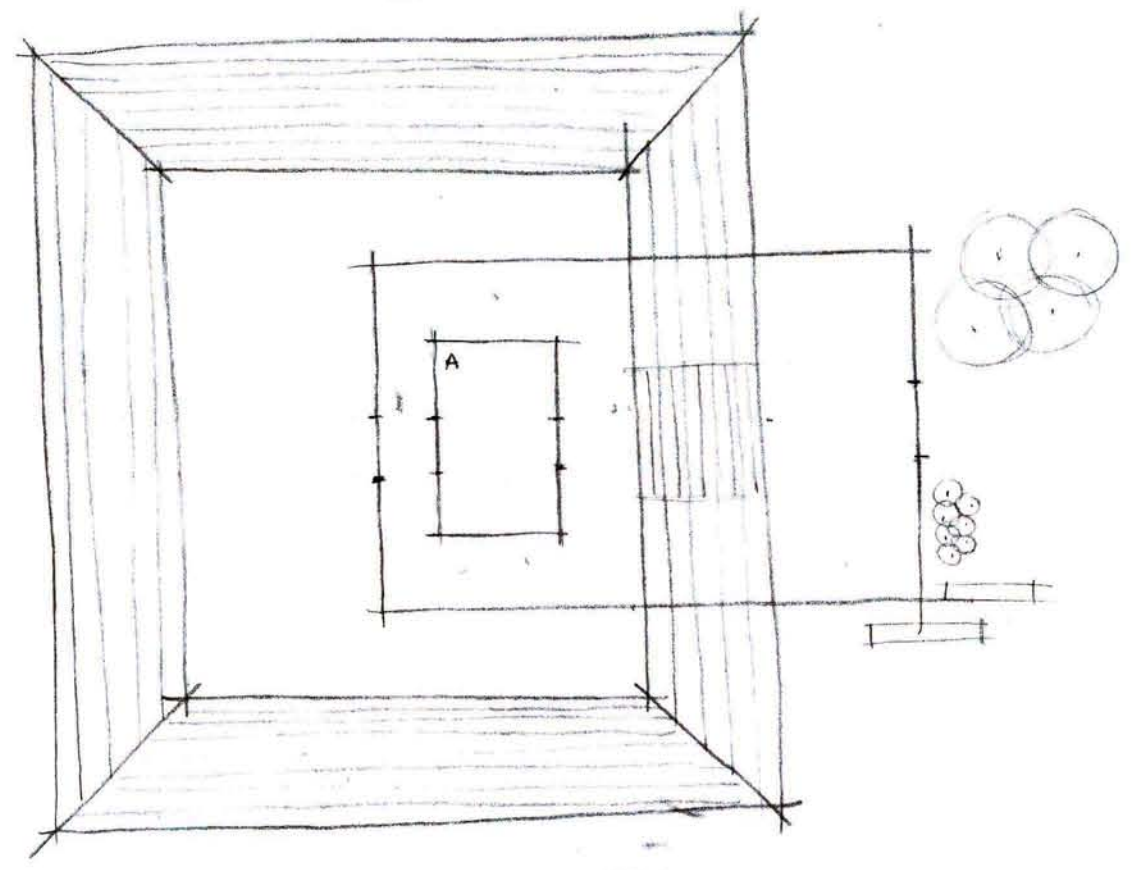
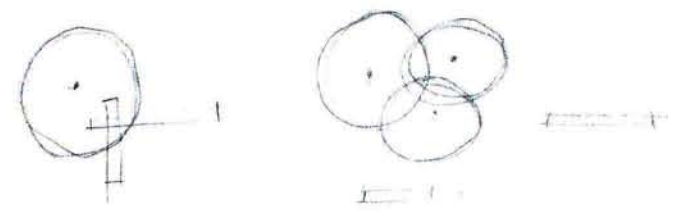
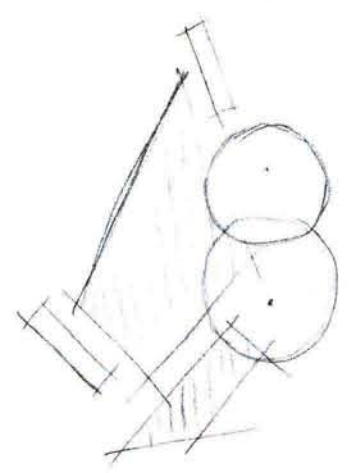

TRG

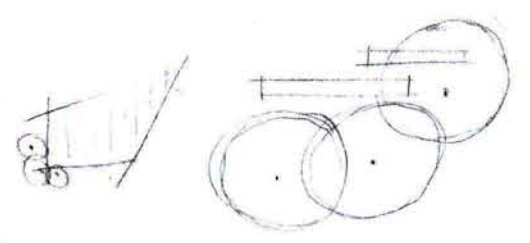
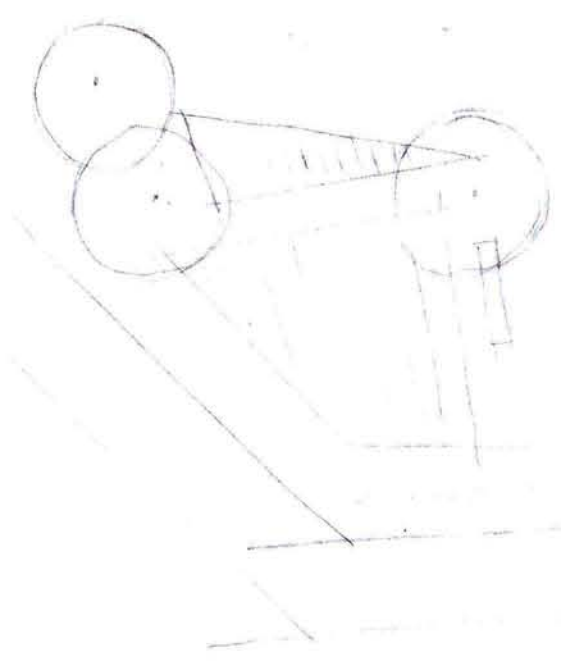

AVENIJA